



Telephone:
+86-318-2321110

Mobile: +86-19133858816 (WhatsApp & WeChat)
E-Mail: Info@dmejde.com
Web: www.jidier.com(Local Market) www.dmejde.com(Global Market)

- DME&JDE Group Headquarters:
1705, Special Business Zone, 211 Youhao Road, Zhongshan District, Dalian, Liaoning, China.
- DME&JDE Hydraulic fluid connector production base:
DME INDUSTRIES CO., LTD
Qiaodong Village, Paotai Town, Puwan New District, Dalian, Liaoning, China.
- DME&JDE Hydraulic fluid hose production base:
HENGSHUI JIDIÉR SPECIAL RUBBER HOSE CO., LTD.
Qian Me Tou Economic Industrial Zone, Hengshui, Hebei, China.
- DME&JDE Hydraulic fluid assembly production base:
DME&JDE FLUID CO., LTD.
Qian Me Tou Economic Industrial Zone, Hengshui, Hebei, China.
- DME&JDE FLUID CO.,LTD:
A-1008 huizhong Plaza Business, Hengshui City,
Hebei Province, China.



Global Market



Wechat Public Account

CERTIFICATE

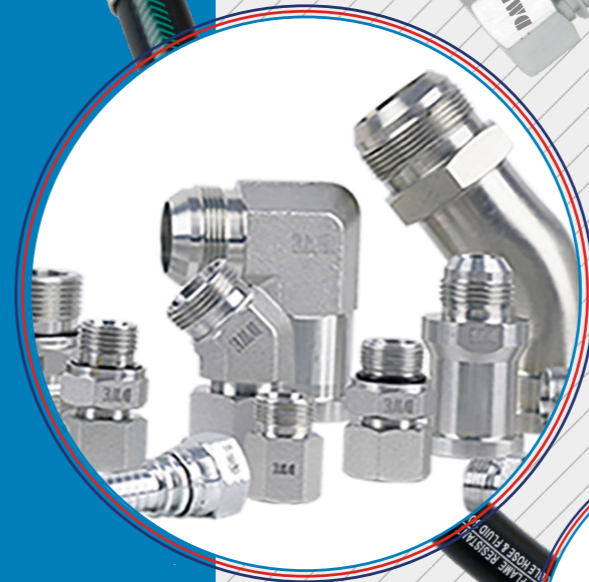

DME&JDE 2024 SUPPORTING PRODUCTS



HYDRAULIC SYSTEM SOLUTION

HYDRAULIC CONNECTORS

HYDRAULIC FLEXIBLE HOSE





CATALOGUE

CRIMPER MACHINE.....	2
CUTTING PRODUCTION.....	11

ASSEMBLY WORKSHOP.....	14
DTJ03A CONNECTOR STORAGE CABINET.....	15
DTF10 TURNOVER CART.....	16
DTF11 TURNOVER CART.....	17
DTF701 TOOL CABINET.....	18
DTJ01A WORKBENCH.....	19
DTA03C WORKBENCH.....	20

CLEANING MACHINE	22
------------------------	----

HOSE WHIP RESTRAINING SYSTEM	28
HOSE WHIP RESTRAINT HOSE COLLAR	30
CABLE ASSEMBLIES FOR FLANGE CONNECTOR	32
CABLE ASSEMBLIES FOR 24 CONE CONNECTOR	33

HOSE BEND RESTRICTOR	36
----------------------------	----

PLASTIC SPIRAL WRAP PROTECTOR	42
-------------------------------------	----

NYLON SLEEVE	48
SHIELD-FLEX NYLON SLEEVE.....	49
EXACT-FLEX FLAME RETARDANT TEXTILE SLEEVE.....	53
EASY-FLEX VELCRO SLEEVE.....	57

CLEAN SEAL CAPSULES (CSC)	60
---------------------------------	----

HYDRAULIC HOSE ASSEMBLY.....	65
------------------------------	----

PVC INDUSTRIAL HOSE.....	82
--------------------------	----

FOREWORD

20 March 2023



FOREWORD

Dear Customer,

Welcome to the world of DME&JDE, DME&JDE is committed to design, manufacture and support fluid transmission solutions. We insist on application-orientation to solve all problems during transmission. Advanced Production technology, wide ranges of flexible hoses, fluid connectors and rich export and projects experience guarantee our capacity to design right OEM fluid solutions for all transmission difficulty.

DME&JDE continuously expands our product ranges and value-added service and improve technologies and equipment to supply products outperform industry standards and exceed customers' demanding expectations.

With regards,

DME&JDE Group

DME & JDE GROUP
www.dmejde.com



 French Technology Equipment

DME&JDE



TECH Powered by :



rexroth
A Bosch Company



Shlinorde
Electric

MANUAL

SCM120A-MiNi
SCM120A-Push
SCM120A-Pro
SCM120A-ProMax
SCM120A-ProMax-Rs



 Web: www.dmejde.com
 E-Mail: info@dmejde.com

 Tel: +86-318-2321110
 Mobile: +86-19133858816 (WhatsApp & WeChat)

HOSE
CRIMPER

MODEL NUMBER

DME&JDE
SCM120A-PRO

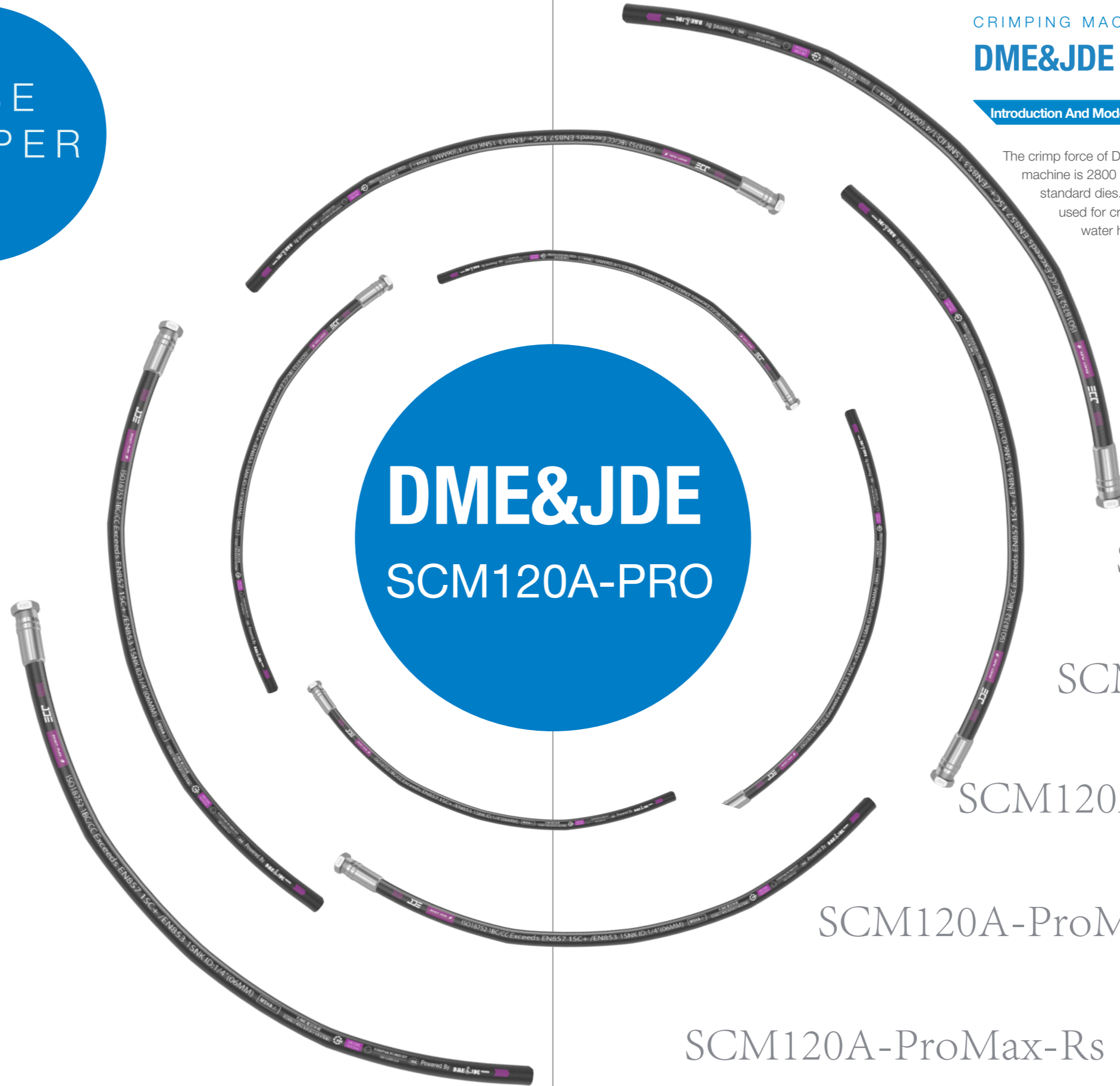

CRIMPING MACHINE

DME&JDE SCM120A-Pro

Introduction And Model Number

The crimp force of DME&JDE SCM120A-PRO hydraulic hose crimping machine is 2800 KN, with a crimp range of 1/4 and -2" sets of standard dies. DME&JDE SCM120A-PRO crimpers are widely used for crimping high-pressure fuel pipes, industrial hoses, water hoses, automobile air bags and wire ropes etc.

SCM120A-Push

SCM120A-Pro

SCM120A-MiNi

SCM120A-ProMax

SCM120A-ProMax-Rs

CRIMPING MACHINE

DME&JDE SCM120A-Pro

DME&JDE SCM120A-Pro hydraulic hose crimping machine is an flexible and multi-functional design. Compact design and slim structure conforms to ergonomics and smart control system make it high user-friendliness. It is applicable for crimping of 4 or 6 spiral wires reinforcement hoses up to 2-1/2 inches diameters. It is also an innovative design. Bright colors, lights designs as well as logo and model display will redefine the crimping machine and will lead a fashion way.

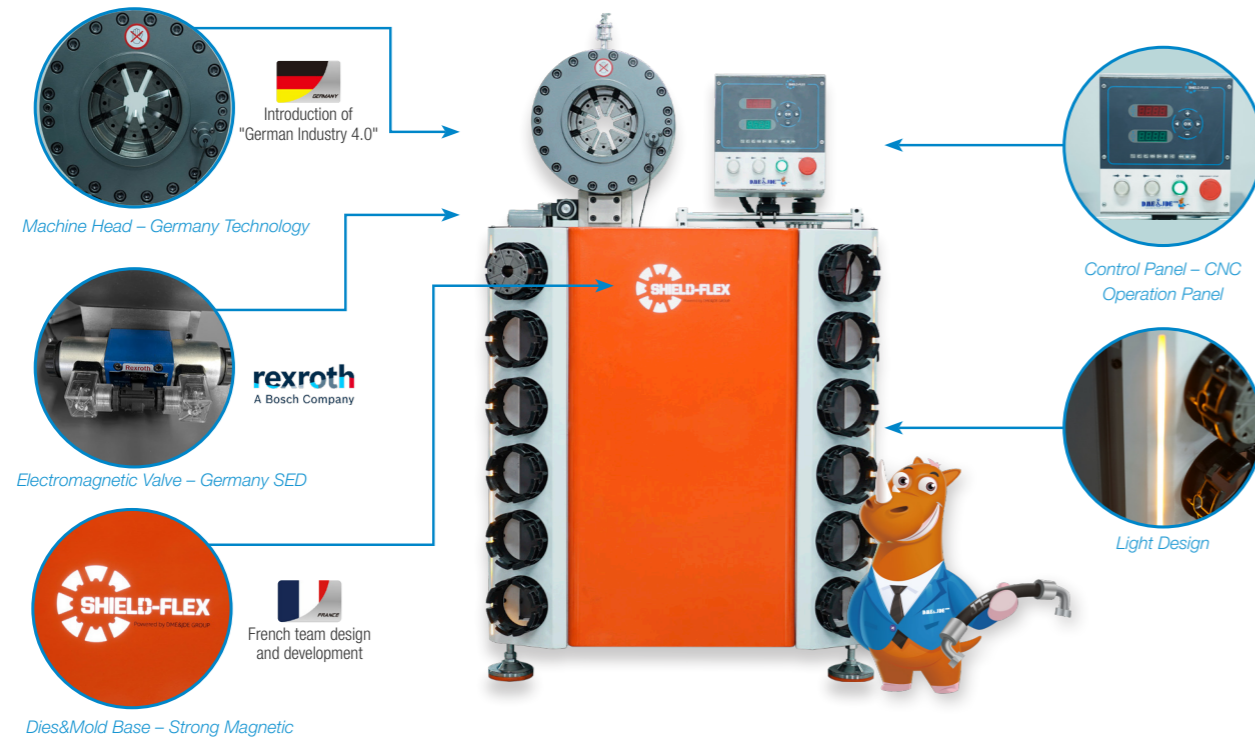

Features

- ▶ Novel appearance.
- ▶ Operation in line with manual functional science
- ▶ The patented product of mold replacement tool, 100% efficiency improvement and easy operation
- ▶ Machine head adopts one piece forging parts with high strength.
- ▶ 12 sets of molds are provided to fit your crimping requirements. And all molds are treated through 2 times of vacuum polishing, with a high degree of finish and long service life.

Details



Model Mark

Vientiane Bracket

Quick-change system for easy replacement of die molds

12 sets of molds are prepared for most of crimping ranges.

Web: <https://www.dmejde.com>
E-mail: info@dmejde.com

CRIMPING MACHINE

DME&JDE SCM120A-Pro

Specification

▶ **Technical Data**

Crimp head material	Forge steel
Crimp range	1/4" to 2-1/2"
Max. opening without dies	122 mm
Max. die opening	28 mm
Motor & Voltage	3 kW / 380 V
Cycle time	7 seconds
Oil tank volume	65 L
Control	Number control
Foot pedal	Included
Noise level	69 dB
Die sets	12 sets
L x W x H	820 x 615.67 x 1200 mm

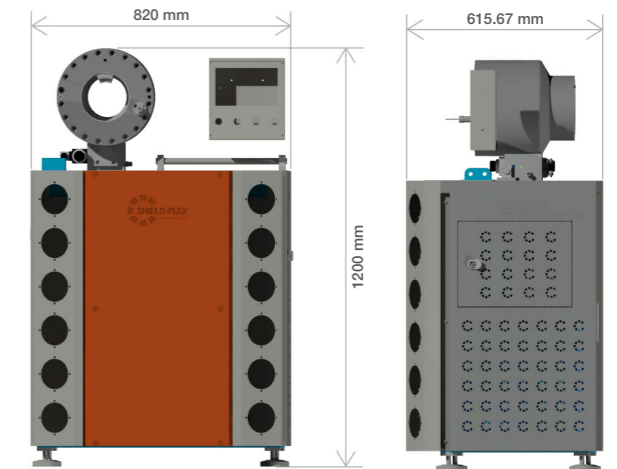

▶ **High Pressure Dies Specification**

Number	Die No.	Crimp Range (mm)	D (mm)	L (mm)
1	14	14-16	14	65
2	16	16-19	16	65
3	19	19-22	19	65
4	22	22-26	22	65
5	26	26-30	26	65
6	30	30-34	30	65

Number	Die No.	Crimp Range (mm)	D (mm)	L (mm)
7	34	34-39	34	70
8	39	39-45	39	70
9	45	45-51	45	80
10	51	51-57	51	80
11	57	57-63	57	90
12	63	63-69	63	90

Notes: standard die sets are included, others are options.

Spare Parts



Web: <https://www.dmejde.com>
E-mail: info@dmejde.com

CRIMPING MACHINE

DME&JDE SCM120A-Pro

Details

The oil cylinder cover, oil tank and piston rod are made of 40 chromium, with a surface hardness of SCM120A-Pro and an operation layer hardness of SCM120A-Pro. The hardened layer is 2 mm thick. The 40 chromium is high pressure resistant and tear resistant with great impact absorbing and carrying capacity. Therefore, the oil tank and piston rod are more durable.

Operation

The oil pump is immersed in hydraulic oil inside the oil tank for cooling and silence. The oil pump is driven using an electric motor and the hydraulic oil is pumped out, pushing the plunger in the oil tank. As a result, the die set compresses in a radial direction and crimps the hose connector. When the compression amount reaches the predetermined value, the compression will automatically stop. Then the magnetic reversing valve switches the direction and the plunger moves backwards. As a result, the die set expands and the hose crimping process is finished.



Introduction and selection of

CRIMPING DIES / MOLDS

Features

As an addition to standard dies DME&JDE Group has special dies in stock or OEM produce for most common crimping applications. Including:

- ▶ Hydraulic hose fittings specific standard type
- ▶ Different dimensions
- ▶ Small and big diameters
- ▶ Extra short and long die sets
- ▶ Customized shapes Dies for applications
- ▶ Air Conditioning (AC)
- ▶ Brake hoses
- ▶ Cable crimps
- ▶ Pipe crimps
- ▶ Crimping of steel pipes or steel bars
- ▶ Crimping of steel pipes or iron square pipes

Special Crimping Applications

We have 20 years of experience in the crimping industry, and our team members are founding members of crimping companies. We also manufacture customer specific tooling to fit the individual needs of your application. Everything from modifying already working tool designs to creating totally new solutions for even the most demanding crimping challenges.

Special Dies

We provide customized dies machined and with industrial metal additive manufacturing. We can manufacture special dies :

- ▶ Supply serve users from over 100 countries
- ▶ Focus on product quality and warranty time
- ▶ Specialize in providing solutions and plans
- ▶ With fast development, test and delivery cycles
- ▶ Without geometrical manufacturing limits
- ▶ For the toughest use-cases



CRIMPING MACHINE

DME&JDE SCM120A-Pro

High pressure crimper dies type List :

NO.DME&JDE-CR-Dies-01

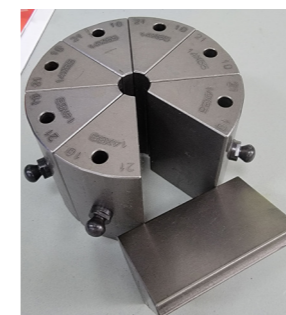

Crimper Dies Type
Standard Crimper Dies

NO.DME&JDE-CR-Dies-02



Crimper Dies Type
Marking / Embossed Crimper Dies

NO.DME&JDE-CR-Dies-03



Crimper Dies Type One Bubble Crimping Dies

NO.DME&JDE-CR-Dies-04



Crimper Dies Type
Two Bubble Crimping Dies

NO.DME&JDE-CR-Dies-05

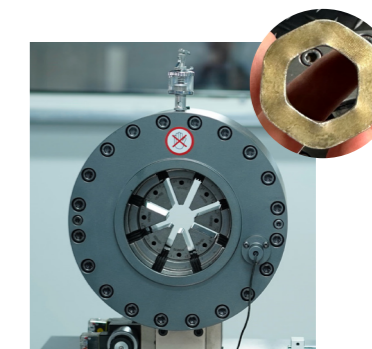

Crimper Dies Type
Hexagonal Crimping Scheme (Popular)

CRIMPING MACHINE

DME&JDE SCM120A-Pro

NO.DME&JDE-CR-Dies-06

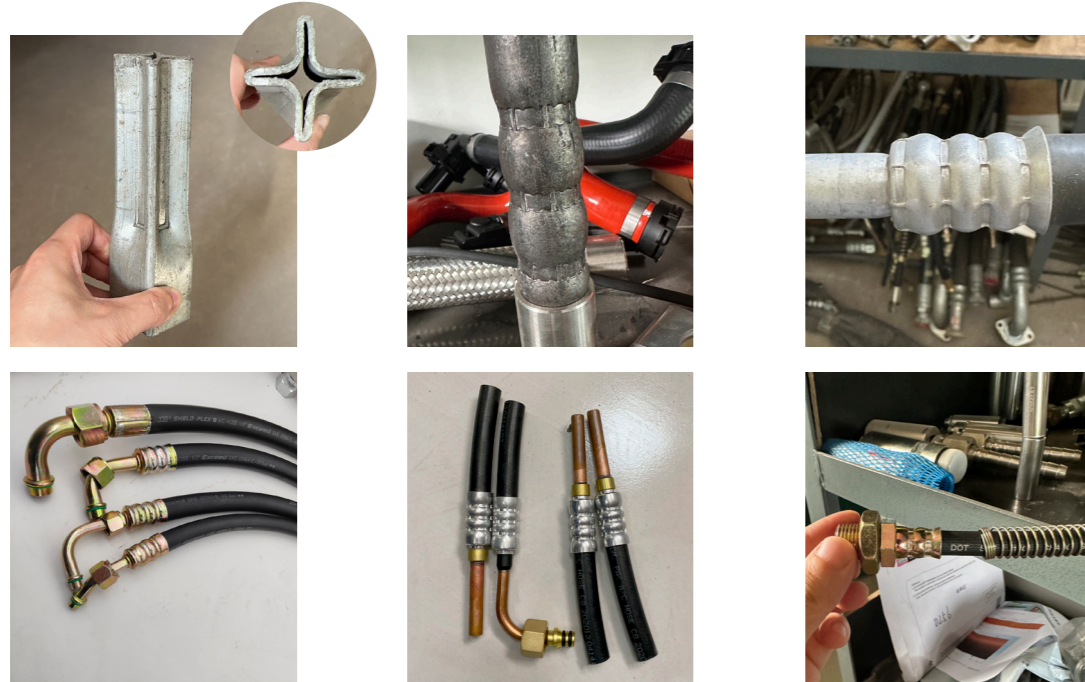

Crimper Dies Type Customized OEM Solution (some pictures)

Equipment production capacity

With years of experience, DME&JDE is always developing and continuing to grow. Visit the company and the workshop to learn more about the spirit, culture and strength of DME&JDE. Advanced equipment and strict working principles ensure that hydraulic hoses, hydraulic fluid connector fittings and hose assemblies meet or exceed international standards.



Web: <https://www.dmejde.com>
E-mail: info@dmejde.com

CRIMPING MACHINE

DME&JDE SCM120A-Pro

Equipment quality control, packaging and warehousing

Strict quality control systems ensure that products are qualified and even exceed industry standards to reduce defect rates, reduce downtime, and improve equipment performance. The standard packing guarantees the perfect condition of the product. Customized packaging provides more possibilities to meet the requirements of different agents and customers, eliminating worries.



Web: <https://www.dmejde.com>
E-mail: info@dmejde.com

CUTTING PRODUCTION

DME&JDE 56D-Pro

DME&JDE-Power DME&JDE 56D-Pro hose-cutting machine has been designed to cut up to 2" diameter 6-spiral hoses. The hose is pushed against the blade by a pneumatic pusher.

Pusher movement speed can be quickly and easily adjusted to choose optimal cutting speed for every hose. The blade can be sharpened when necessary. The cutter has a built-in bin for collecting cutting waste.

SAFE- and QT-models also available.



French Technology Equipment

DME&JDE



SCM56D-Pro



Specification

► Technical Data

Max. hose size (inch)	2
Diameter (blade) external	520 x 4
Diameter (blade) internal	38
Max. hose OD	71
Motor Power (kW/HP)	7.5 / 10.0
Velocity, 50 Hz	2840
Velocity, 60 Hz	2840

► Dimensions (LxWxH)

mm	990 x 714 x 1318
inch	39.0 x 28.2 x 51.9

► Weight

kg / lbs	300 / 485
----------	-----------

► Standard Features

Toothed blade
Adjustable pneumatic pusher speed
Adjustable hose support
► Options
Measuring table (2 m segments)
Fume extractor
Smooth blade

Measuring table (left / right handed) as an option.



**FURTHER INFO ON OPTIONS,
PLEASE REVERT TO SPECIFIC PRODUCT CARD**

www.dmejde.com



Web: www.dmejde.com
E-Mail: info@dmejde.com

Tel: +86-318-2321110
Mobile: +86-19133858816 (WhatsApp & WeChat)

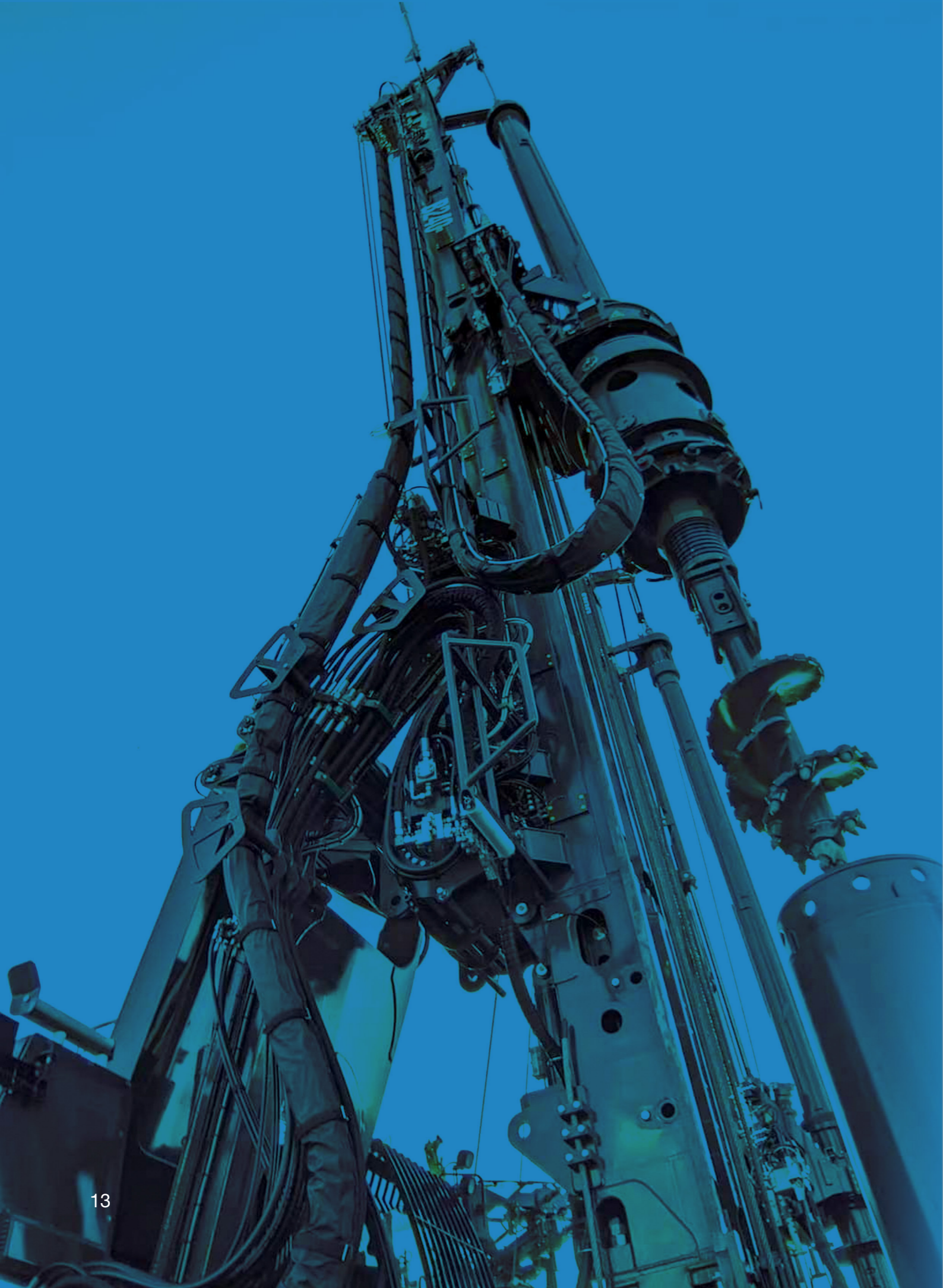

DME&JDE Assembly Workshop

– Operating table

– Turnover Carts



YOUR CONNECTORS & HOSES OEM SOLUTIONS

Connector Storage Cabinet DME&JDE DTJ03A

DME&JDE DTJ03A connector storage cabinet is a heavy-duty connector storage cabinet with excellent resistant to oils, acids, bases and impact. It is equipped with optional 5 drawers to help you to classify your hose connectors and hose fitting by categories and provide a simple and effective connector storage management.



► Technical Parameters

unit: mm

Model	Width (W)	Depth (D)	Height (H)
DTJ03A	1500	750	800
Note	A tool chest with five drawers		

Features

- **Table Top**
 - Standard configuration, the total thickness of the table top is 50 mm.
 - The base material of the table top is high pressure forming fiberboard. The surface is high pressure attaching 2 mm thick polymer compound material. The surface is patterned, more wear-resisting. PVC long sealing strip around the edge.
- **Drawer Cabinets**
 - Drawer can do 3 x 3 partition, can adjust the partition space arbitrarily, drawer handle belt special design safety locking system.
 - Optional 5-drawer cabinet or 2-drawer cabinet can be placed under the table on the left or right side.
- **Table Legs**
 - The table legs are made of high quality cold-rolled steel 2.0 mm thick.
- **Pad Feet**
 - All-metal pad feet, adjustable countertop balance, shockproof and moisture-proof

Turnover Cart DME&JDE DTF10

DME&JDE DTF10 turnover cart is a 3-layer trolley equipped with four wheels for worry-free transport. It is suitable for placing metal & plastic turnover boxes as well as various kinds of tools, products and mechanical parts, to facilitate material transportation during production.



► Technical Parameters

unit: mm

Model	Width (W)	Depth (D)	Height (H)
DTF10	845	436	915

Features

- **Handle**
 - The side of the cabinet is equipped with nylon handle, which is beautiful and practical.
- **Tray**
 - Tray inside dimensions: 775 mm wide x 410 mm deep x 40 mm high.
- **Wheel**
 - Using 5" PU wheel (2 directional wheels and 2 universal brake wheels), the average load of 4 wheels is 400 kg.

Turnover Cart

DME&JDE DTF11

DME&JDE DTF11 turnover cart is a 3-layer trolley equipped with a square hole back panel and four wheels for worry-free transport. It is suitable for placing metal & plastic turnover boxes as well as various kinds of tools, products and mechanical parts, to facilitate material transportation during production.



► Technical Parameters

unit: mm

Model	Width (W)	Depth (D)	Height (H)
DTF11	845	436	915 + 390

Features

- Back Panel
 - Square hole back panel can be matched with all kinds of hooks, hang different kinds of tools and articles.
 - Accessories to be purchased separately.
- Handle
 - The side of the cabinet is equipped with nylon handle, which is beautiful and practical.
- Tray
 - Tray inside dimensions: 775 mm wide × 410 mm deep × 40 mm high.
- Wheel
 - Using 5" PU wheel (2 directional wheels and 2 universal brake wheels), the average load of 4 wheels is 400 kg.

Tool Cabinet

DME&JDE DTF701

DME&JDE DTF701 tool cabinet is a light-duty tool cabinet and is suitable for storing tools, accessories and various items needed for production. In addition, it can be placed on CNC lathes, grinders, machining centers, and shop floors for smooth production.



► Technical Parameters

unit: mm

Model	Width (W)	Depth (D)	Height (H)
DTF701	600	600	880 + 450
Drawer: 100 mm × 4, 200 mm × 1			

Features

- Back Panel
 - Square hole back panel can be matched with all kinds of hooks, hang different kinds of tools and articles.
 - Accessories to be purchased separately.
- Quarter Panel
 - The quarter panel with screws to secure the back panel.
- Non-Slip Rubber Pad
 - The top three sides of the cabinet block design, to prevent items fall, standard with a piece of non-slip rubber pad, to prevent paint above the cabinet damaged.
- Rod Lock Device
 - Unscrewed connecting rod lock device, once locked, all drawers are locked.
- Aluminum Alloy Handle
 - Full-width aluminum alloy handle with label paper, easy to label the name of the articles.
- Hidden Safety Lock System
 - Drawer aluminum alloy handle with special design of hidden safety lock system, without manual operation, drawer do not slide out fall, ensure the safety of use.
- Drawer
 - The drawer is equipped with 2 separate bars and 6 movable slots. The slots can be adjusted with the slot bars.
 - Drawer slide rail with mechanical bearings, strong and durable.
 - Internal dimensions of drawers: Width 492 mm × depth 498 mm, average load per drawer 100 kg.
- PU Wheel
 - Using 5" PU wheel, 2 directional wheels, 2 universal brake wheels, moving light and flexible, the average load of four wheels 500 kg.

Workbench

DME&JDE DTJ01A

DME&JDE DTJ01A workbench is a light duty workbench for assembling products, storing testing equipment and small processing equipment such as drills and grinders. It helps our workers to work smoothly and orderly and facilitates our production efficiency.



► **Technical Parameters**

unit: mm

Model	Width (W)	Depth (D)	Height (H)
DTJ01A	1500	750	800

Features

- **Table Top**
 - Standard configuration, the total thickness of the table top is 50 mm.
 - The base material of the table top is high pressure forming fiberboard. The surface is high pressure attaching 2 mm thick polymer compound material. The surface is patterned, more wear-resisting. PVC long sealing strip around the edge.
- **Table Legs**
 - The table legs are made of high quality cold-rolled steel 2.0 mm thick.
- **Pad Feet**
 - All-metal pad feet, adjustable countertop balance, shockproof and moisture-proof.

Workbench

DME&JDE DTA03C

DME&JDE DTA03C workbench is a light duty, detachable workbench widely used in testing, maintenance and product assembly applications. It can work with back panel, drawers and tool kits for assembling products, storing testing equipment and small processing equipment such as drills and grinders for efficient production.



► **Technical Parameters**

unit: mm

Model	Width (W)	Depth (D)	Height (H)
DTA03C	1500	600	770

Features

- **Table Top**
 - Standard configuration, the total thickness of the table top is 30 mm.
 - Impact-resistant composite patterned table top is made of high-pressure formed fiberboard. High-pressure attached to the surface of 2 mm thick polymer composite. The surface is patterned, more wear-resistant. PVC long sealing strip around the edge.
- **Column**
 - Desktop to ground height default 770 mm high, suitable for sitting operation. Another 850 mm and 900 mm height can be selected. Instructions for ordering.
- **Tool Kit**
 - The table can be equipped with more than one tool kits. Tool kits can be installed on the left or right side of the table and can be stacked up and down or arranged in a line.
 - Tool kits can be purchased separately.

(portable pneumatic tools)

Cleaning Machine



D&JDE GROUP
YOUR CONNECTORS & HOSES OEM SOLUTIONS



SERIES OF D&JBS

Cleaning Machine (portable pneumatic tools)

DME&JDE D&JBS

Basic Introduction

Cleaning machine: D&JBS series represent the products imported from abroad by our company to generate our own brand path. This kind of products has been designed neither for any other companies, nor for the else products and other products promotion or publicity, but for the main push of our own brand. Our company can guarantee the quality through the mature products and maintain the credit and honor through honest. The customers can be well served by the professional techniques and the superior after-sales services. This is our guarantee and our purpose for our customers. Through the way of pushing our own brand, our company has also carried the technologies expansion in China market and products sales work, so does the after sale service and the quality checks.



Basic Principle

The basic principle of the D&JBS series is compressing the air as power, shooting the high polymer materials whose size is bigger than the tube diameter into the inner tube. The polymer materials move fast through the inner tube wall and rub the wall so as to achieve a physical cleaning method. The normal operating air pressure is: 4kg-10kg.

Basic Function

This machine adopts the size 2-2000mm tube wall and can be used among in any size between these specifications. The polymer materials can clean the dirt, dust, and all the impurities adhered to the pipe with harmless to environment as well as the human body, which can provide the convenient and quick cleaning way. The polymer's speed can be accelerated up to about 1km/min in the tube.



Cleaning Machine (portable pneumatic tools)

DME&JDE D&JBS

Basic Efficiency



The cleaning method of cleaning machine D&JBS series can avoid the environmental pollutions brought by the chemical cleaning and also solve the water waste of high pressure water washing method. Besides, the chemical cleaning will have remains and the high pressure water's washing is not complete and easily operated. However, this machine will solve all the problems above. Comparing with the normal cleaning methods, about 90% of time can be saved. This product can be used in any form of tube such as 90 degree angle, "T" type joint, chain type joint and "U" type tube. The complicated snake chain type avoids the ills provided by high pressure water and chemical cleaning. The high speed moving polymer materials, along with the economically safe air compressing, will bring no harm to the operator and various ancillary facilities. This method can test whether the machine is clean or not while cleaning the machine.

Basic Scope

- ▶ Engineering machine and hoisting equipment products of machine manufacturing industries.
- ▶ Condenser, heat exchanger and evaporator products of air conditioning and air freezing machines.
- ▶ Assembly maintenance cleaning products of hydraulic transmission system of aerospace field.
- ▶ The hydraulic support and hydraulic transmission system, cleaning, assembly, maintenance exclusion of coal mine industries.
- ▶ Fuel pipeline transport system of maritime navigation and facilities of cleaning, shipping, assembling and maintaining.
- ▶ Cleaning products before the assembly of the pipe, the raw material on the delivery pipe and the residue of the pipe to clean the pipe, clean multi curved valve pipe cleaning tube of food industry.
- ▶ Warships, aircraft, rocket launchers, tanks and artillery, engineering transport vehicle fuel pressure transmission system, artillery barrel, hydraulic system of national defense industries.

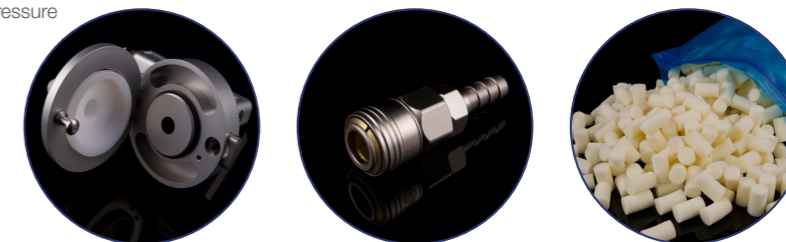



Cleaning Machine (portable pneumatic tools)

DME&JDE D&JBS

Basic Specifications

► Machine D&JBS

D&JBS Series	Inlet Diameter	Joint	Normal Air Pressure Demand
D&JBS-60	11mm	5-60mm	4kg-10kg
D&JBS-55-2	11mm	6-50mm	4kg-10kg
D&JBS-50-1	11mm	5-50mm	4kg-10kg
D&JBS-32	11mm	5-32mm	4kg-10kg
D&JBS-60	11mm	6-50mm	4kg-10kg

6.D&JBS series polymer material products can be used in any material tube and any bending tube, including hoses, pipes, metal piped without connecting fittings. The large size of particles can be removed and remain liquid can be recycled. The size of chosen polymer material should be larger than 30% of inner tube diameter.

7.White emission mouth can be used in hose, thick wall, thin wall, pipe, metal pipe and connect inner the tube.

8.White emission mouth can be used in metal pipe, no joint thin-walled steel tube, connector hose and connect outer the tube.

Cleaning Machine (portable pneumatic tools)

DME&JDE D&JBS

Basic Operation



1.Operating field must have the complete clean and dry air and the cleaning machine should also be clean. The handle part of D&JBS-60 series products is inner part. The joint connector should be accompanied with the tube specifications. After choosing the right type shooter, the right polymer material should be put into the shooter and then tighten the disk and lock the bayonet. No people at the outer place.

2.Try the empty gun to make sure if there is a leak. Check if the diameter of cleaning tube can be tightened the shooter. Only if there remains one inlet and outlet, the operation can be continued. The polymer materials should be recycled with appropriate ways to make sure if the cleaning degree is all right or meet the requirement of cleaning. Then choose whether use the material again to meet the cleaning standard.

Basic Introduction

1. Make sure the appearance of product host is clean and grips with supplies and connecting head plus emission mouth is correctly placed.
2. Vaseline oil should be used in connecting head, connecting plate and launching nozzle to ensure the daily maintenance.
3. The polymer should be put half of meter high above the ground to make sure the moisture proof. The materials should also avoid the light and remain sealed for the fading color after being exposed in the sun.

Notes

When start cleaning the "T" type tube, the one side end should be the inlet air part and one of the top ends should be technically managed, and then make the other end as outlet. When meeting the various pipe lines, the polymer materials should be used 10% smaller than the tube wall, in case that the bigger one stuck in the tube. However the cleaning tube material should be 10% larger than the tube. When the inappropriate operation leads to the choke, the operator shall not be so worried. Just blow the gun out of the direction of the compressed air to wait for the material injection.



DME&JDE

- Hose Whip Restraining System



DME&JDE Hose Whip Restraining System

Hose whip restraining system is one of the most common accessories for fluid hoses in use and consists of two parts: the hose collar and hose whip restraint cable assemblies. The hose collar and one end of the cable assemblies are connected to the fluid hose and then fasten them to the port connector or flange connector.

When the hose is under high pressure, it is easy for a pressurised hose or hose fitting failure, while the hose whip restraint cable can limit the hose to a controlled range, preventing the hose or the splashing liquid from damaging the nearby equipment and injuring the operator near the faulty hose.

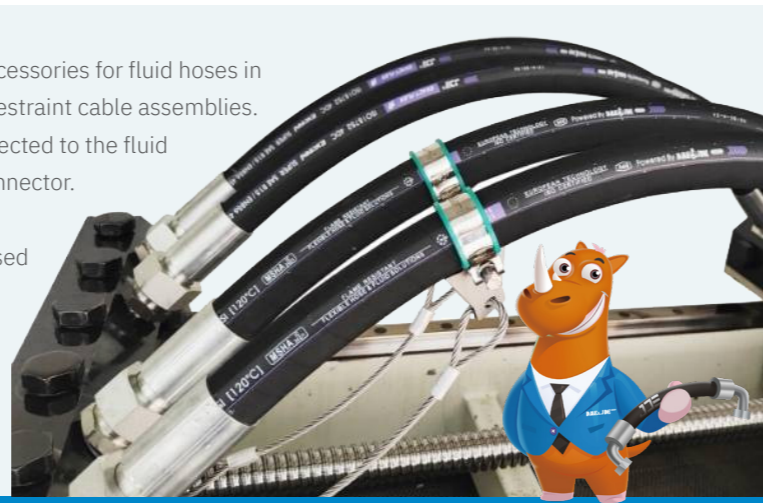

How does it work?



1.Hose Disengaging

The "Hydraulic Safety cable" system does not operate during the step of disengaging the flexible hose, but, if applied correctly, it ensures that the hose is fully disengaged from the ferrule that restrains it. During this step, the flexible hose gains velocity and power due to the pressure increase of the oil contained therein.

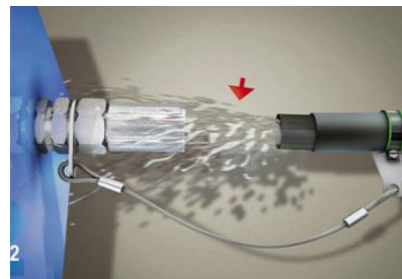

2.Whip Effect

During this step, the pressurised oil exits from the flexible hose. The hose begins to release the energy contained therein, and gains considerable velocity, triggering a hazardous "whip effect" which is very dangerous to anyone or anything in its vicinity.



3.Hose Restraining

Once the hose has been disengaged and the pressure released, the flexible hose can be restrained. This is where the "Hydraulic Safety cable" system gets into operation: the stainless steel cable is tensioned and deformed while the plate cuts into the rubber of the hose, preventing the clamp, firmly attached to the hose, from disengaging. The hose clamp and plate start to deform in turn, elastically absorbing the force released from the travel of the flexible hose.

DME&JDE Hose Whip Restraint Hose Collar – Secure Hose and Prevent Whipping

DME&JDE hose collar is composed of a stainless steel hose clamp and a polyurethane lining. It is a part of the hose whip restraining system and serves to connect the hose during operation. When the hose is under high pressure, it is prone to separating from its fitting. At this point, hose clamp can secure the hose, preventing it from randomly moving and causing injury to operators or damage to nearby equipment when the hose is under pressure.



Details

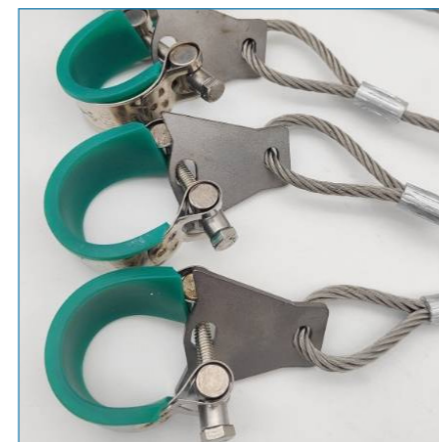

Internal structure



Control panel

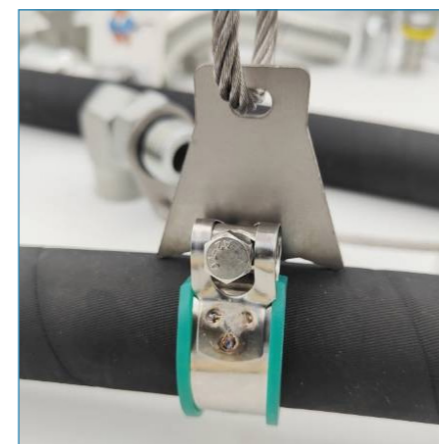

Testing observation



Testing observation



Specification

Table 1: Hose Collar Specifications

Code	Material Steel Grade	ø MIN		ø MAX		Package PCS/carton
		mm	inches	mm	inches	
DME&JDE-STOPFA11115	M6	11	433	11.5	453	10
DME&JDE-STOPFA12125	M6	12	472	12.5	492	10
DME&JDE-STOPFA13135	M6	13	512	13.5	531	10
DME&JDE-STOPFA1415	M6	14	551	15	591	10
DME&JDE-STOPFA1617	M6	16	630	17	669	10
DME&JDE-STOPFA1718	M6	17	669	18	709	10
DME&JDE-STOPFA1819	M6	18	709	19	748	10
DME&JDE-STOPFA2021	M6	20	787	21	827	10
DME&JDE-STOPFA2122	M6	21	827	22	866	10
DME&JDE-STOPFA2223	M6	22	866	23	906	10
DME&JDE-STOPFA2425	M6	24	945	25	984	10
DME&JDE-STOPFA2526	M6	25	984	26	1,024	10
DME&JDE-STOPFA2627	M6	26	1,024	27	1,063	10
DME&JDE-STOPFA2728	M6	27	1,063	28	1,102	10
DME&JDE-STOPFA2829	M6	28	1,102	29	1,142	10
DME&JDE-STOPFA3031	M6	30	1,181	31	1,220	10
DME&JDE-STOPFA3233	M6	32	1,260	33	1,299	10
DME&JDE-STOPFA3435	M6	34	1,339	35	1,378	10
STOPFLEX-STOPFA3637	M6	36	1,417	37	1,457	10
STOPFLEX-STOPFA3839	M6	38	1,496	39	1,535	10
STOPFLEX-STOPFA3940	M6	39	1,535	40	1,575	10
STOPFLEX-STOPFA4041	M6	40	1,575	41	1,614	10
STOPFLEX-STOPFA4243	M6	42	1,654	43	1,693	10
DME&JDE-STOPFA4344	M6	43	1,693	44	1,732	10
DME&JDE-STOPFA4445	M6	44	1,732	45	1,772	10
DME&JDE-STOPFA4547	M8	45	1,772	47	1,850	10
DME&JDE-STOPFA4850	M8	48	1,890	50	1,969	10
DME&JDE-STOPFA5153	M8	51	2,008	53	2,087	10
DME&JDE-STOPFA5354	M8	53	2,087	54	2,126	10
DME&JDE-STOPFA5456	M8	54	2,126	56	2,205	10
DME&JDE-STOPFA5759	M8	57	2,244	59	2,323	10
DME&JDE-STOPFA6062	M8	60	2,362	62	2,441	10
DME&JDE-STOPFA6365	M8	63	2,480	65	2,559	10
DME&JDE-STOPFA6668	M8	66	2,598	68	2,677	10
DME&JDE-STOPFA6971	M8	69	2,717	71	2,795	10
DME&JDE-STOPFA7274	M8	72	2,835	74	2,913	10
DME&JDE-STOPFA7577	M8	75	2,953	77	3,031	10
DME&JDE-STOPFA7880	M8	78	3,071	80	3,150	10
DME&JDE-STOPFA8183	M8	81	3,189	83	3,268	10
DME&JDE-STOPFA8486	M8	84	3,307	86	3,386	10
DME&JDE-STOPFA8789	M8	87	3,425	89	3,504	10
DME&JDE-STOPFA9092	M8	90	3,543	92	3,622	10
DME&JDE-STOPFA9395	M8	93	3,661	95	3,740	10

DME&JDE Cable Assemblies For Flange Connector

– Limit the Trajectory of the Hose



Flange connector cable assemblies are suitable for equipment with flange connectors. One end is connected to the hose collar for fixing the hose, and the other end is secured to the flange connector. In the event of the hose separating from its fitting, high tensile stainless steel flange plate and high tensile stainless steel cable play the role of restraining the hose to limit the trajectory of the hose and avoid causing damage to the nearby equipment or injury to operators.



Specification

Table 1: Specification of Cable Assemblies For Flange Connector

Code	Material Steel Grade	ø mm/inches	SP/TH. mm/ inches	L. mm/ inches	No. of PCS	Max operating pressure Bar/PSI	Cutting Plate
DME&JDE-STOPFUSAE085	M6	8.5	4	300	10	415	Small
		335	157	11,811		6018	
DME&JDE-STOPFUSAE2105	M6	10.5	4	300	10	420	Small
		413	157	11,811		6090	
DME&JDE-STOPFUSAE105	M8	10.5	4	450	10	420	Large
		413	157	17,717		6090	
DME&JDE-STOPFUSAE125	M8	12.5	4	450	10	420	Large
		492	157	17,717		6090	
DME&JDE-STOPFUSAE2125	M6	12.5	4	450	10	420	Small
		492	157	17,717		6090	
DME&JDE-STOPFUSAE145	M8	14.5	4	450	10	420	Large
		571	157	17,717		6090	
DME&JDE-STOPFUSAE165	M8	16.5	4	450	10	420	Large
		650	157	17,717		6090	
DME&JDE-STOPFUSAE205	M8	20.5	4	450	10	350	Large
		807	157	17,717		5075	
DME&JDE-STOPFUSAE25	M8	25	8	550	10	350	Large
		984	315	21,654		5075	
DME&JDE-STOPFUSAE32	M8	32	8	550	10	210	Large
		1,260	315	21,654		3045	



DME&JDE Cable Assemblies For 24 Cone Connector – Ensure the Safety of Operators

24° Cone Connector Cable Assemblies are suitable for equipment with 24° cone male connectors. One end is connected to the hose collar for fixing the hose, and the other end is secured to the 24° cone male connector.

When the hose works under high pressure and separates from its fitting, high tensile stainless steel cable and stainless steel connection plate can ensure that under high impact conditions, the cable assembly will not break and limit the movement of the hose to a certain range to avoid splashing liquid causing injury to surrounding operators.



Details



Specification

Table 1: Specification of Cable Assemblies for 24° Cone Connector

Code	Material	φ	SP/TH.	L.	No. of PCS	Max operating pressure	Cutting Plate
-	Steel Grade	mm/inches	mm/inches	mm/inches	-	Bar/PSI	-
DME&JDE-STOPFUDIN145	M6	14.5	2	300	10	450	Small
		571	79	11,811		6525	
DME&JDE-STOPFUDIN17	M6	17	2	300	10	445	Small
		669	79	11,811		6453	
DME&JDE-STOPFUDIN185	M6	18.5	2	300	10	420	Small
		728	79	11,811		6090	
DME&JDE-STOPFUDIN205	M6	25	2	300	10	420	Small
		807	79	11,811		6090	
DME&JDE-STOPFUDIN225	M6	22.5	2	300	10	420	Small
		886	79	11,811		6090	
DME&JDE-STOPFUDIN245	M6	24.5	2	300	10	420	Small
		965	79	11,811		6090	
DME&JDE-STOPFUDIN265	M6	26.5	2	300	10	420	Small
		1,043	79	11,811		6090	
DME&JDE-STOPFUDIN305	M6	35	2.5	300	10	420	Small
		1,201	98	11,811		6090	
DME&JDE-STOPFUDIN34	M8	34	2.5	450	10	420	Large
		1,339	98	17,717		6090	
DME&JDE-STOPFUDIN365	M8	36.5	2.5	450	10	420	Large
		1,437	98	17,717		6090	
DME&JDE-STOPFUDIN2365	M6	36.5	2.5	450	10	420	Large
		1,437	98	17,717		6090	
DME&JDE-STOPFUDIN425	M8	42.5	2.5	450	10	420	Large
		1,673	98	17,717		6090	
DME&JDE-STOPFUDIN455	M8	45.5	2.5	450	10	420	Large
		1,791	98	17,717		6090	
DME&JDE-STOPFUDIN2455	M6	45.5	2.5	450	10	420	Large
		1,791	98	17,717		6090	
DME&JDE-STOPFUDIN49	M8	49	2.5	450	10	420	Large
		1,929	98	17,717		6090	
DME&JDE-STOPFUDIN525	M8	52.5	2.5	450	10	385	Large
		2,067	98	17,717		5583	
DME&JDE-STOPFUDIN60	M8	60	2.5	450	10	350	Large
		2,362	98	17,717		5075	



Hose Bend Restrictor

DME & JDE GROUP
YOUR CONNECTORS & HOSES OEM SOLUTIONS



DME&JDE Company Profile



During fluid transmission industries, you may have lots of problems to solve and want to find a convenient way for efficient working. DME&JDE aims to supply the full line of flexible hoses, fluid connectors and hose assemblies for one-stop purchase. Moreover, we aim to tackling challenges during fluid transmission and supply total solution to make all media can transfer smoothly at any harsh environments.

Downtime and inefficiency can cost millions of dollars for projects. DME&JDE aims to tackling challenges and solve all media, condition and other blocks during fluid transfer system to decrease downtime, increase efficiency, extend service life and enhance safety.



Hose Bend Restrictor

Hose bend restrictor is a device used to limit the bending radius of a hose. Add hose bend restrictor onto hose end to prevent kinks or tight bends and extending the service life of numerous hydraulic and pressure-washer hoses.

It can be divided into two types: straight sleeve bend restrictor and 4-finger bend restrictor. Sleeve straight types is more easier to install and the four-finger type makes the grip more easier.



DME&JDE-4-Finger Bend Restrictor

4-finger hose bend restrictor can reduce bending stress near the hose-coupling junction & prevent it from kinks.

The unique concave and convex shape of this grip makes customer's handlebar more comfortable and easier to use, while the glossy vinyl material makes the surface extremely bright and colorful.

Specification

4-finger hose bend restrictors are available to fit the most popular sizes, but it also can be incorporated into a wide variety of custom grip designs.



Features & Benefits

- Easy to grip
- Prevent damage near ends
- Exceptional anti-crushing performance, stress cracking resistance, load bearing strength
- Resistant to acids, oils and solvents
- High abrasion resistance
- UV resistance
- Proven in arduous conditions
- Self lubricating to reduce wear on hoses and cables
- Suitable for wrapping single or multiple hose bundles. Fit most types of hydraulic, pneumatic and industrial hose assemblies
- Excellent for use in temperature ranges of -40 °C to +150 °C
- Greatly extends the working life of hydraulic hoses

DME&JDE Smooth Hose Bend Restrictor

Smooth hose bend restrictor is a popular hose bend restrictor with cylindrical structure. It has straight types and flared end types. The flare end design has a beaded locking feature that provides a secure fit over the coupling and offers relief from strain. Either style prevents kinks in the hose line at the connection point saving wear and tear caused by the stress from twisting and bending.

Moreover, the vinyl material sleeve make the grip easier when using the rubber hoses for cleaning and other operation.

Specification

Hose Guards (hose bend restrictors) are available to fit the most popular sizes, but it also can be incorporated into a wide variety of custom grip designs.



Features & Benefits

- Good toughness.
- Corrosion and aging resistance.
- Good elasticity.
- Large variety of color choices
- Wide range of sizes and customizable.
- Customized logos are accepted.





DME&JDE-4-Finger Bend Restrictor
For Hose Bending Stress Reduction

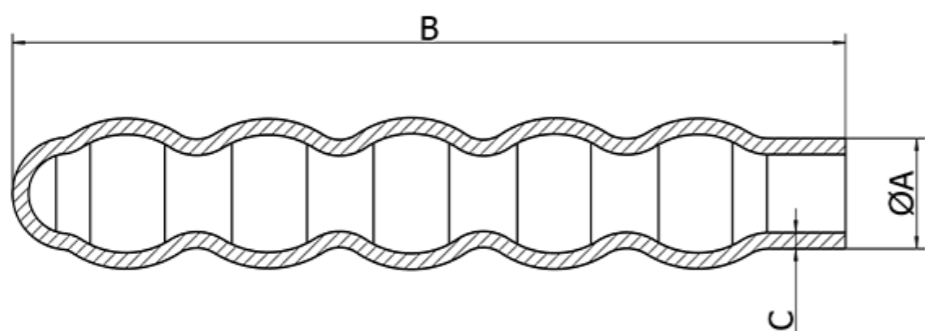

Table 1: Specification of 4-Finger Hose Bend Restrictor

Inside Diameter "A"		Max Inside Length "B"		Nominal Wall Thickness "C"			
				Econo Wall		Heavy Wall	
in	mm	in	mm	in±0.10	mm±0.25	in±0.10	mm±0.25
0.591	15.00	5.906	150.00	0.079	2.00	0.118	3.00
0.717	18.20	5.906	150.00	0.079	2.00	0.118	3.00
0.866	22.00	5.906	150.00	0.079	2.00	0.118	3.00
1.142	29.00	5.906	150.00	0.079	2.00	0.118	3.00
1.516	38.50	5.906	150.00	0.079	2.00	0.118	3.00

DME&JDE Smooth Hose Bend Restrictor
For Extending Service Life



Table 1: Specification of Smooth Type Hose Bend Restrictors

Series Number	Inside Diameter "A"		Inside Length "B"				Inside Diameter "D"		Opening Diameter "E"	
	(inch)	(mm)	Typical (inch)	Typical (mm)	Max. (inch)	Max. (mm)	(inch)	(mm)	(inch)	(mm)
0.75"	0.750	19.05	3.500	88.90	3.50	88.90	1.117	28.37	0.669	16.99
0.812"	0.812	20.62	3.500	88.90	5.00	127.00	1.140	28.96	0.650	16.51
0.890"-1	0.890	22.61	3.500	88.90	5.00	127.00	1.140	28.96	0.866	22.00
0.890"-2	0.890	22.61	3.500	88.90	5.00	127.00	1.140	28.96	0.689	17.50
0.952"-1	0.952	24.18	3.500	88.90	5.00	127.00	1.142	29.01	0.768	19.51
0.952"-2	0.952	24.18	3.500	88.90	5.00	127.00	1.142	29.01	0.875	22.23
1.125"	1.125	28.58	3.500	88.90	3.50	88.90	1.325	33.66	0.866	22.00
1.250"	1.252	31.80	3.500	88.90	3.50	88.90	1.437	36.50	1.024	26.01

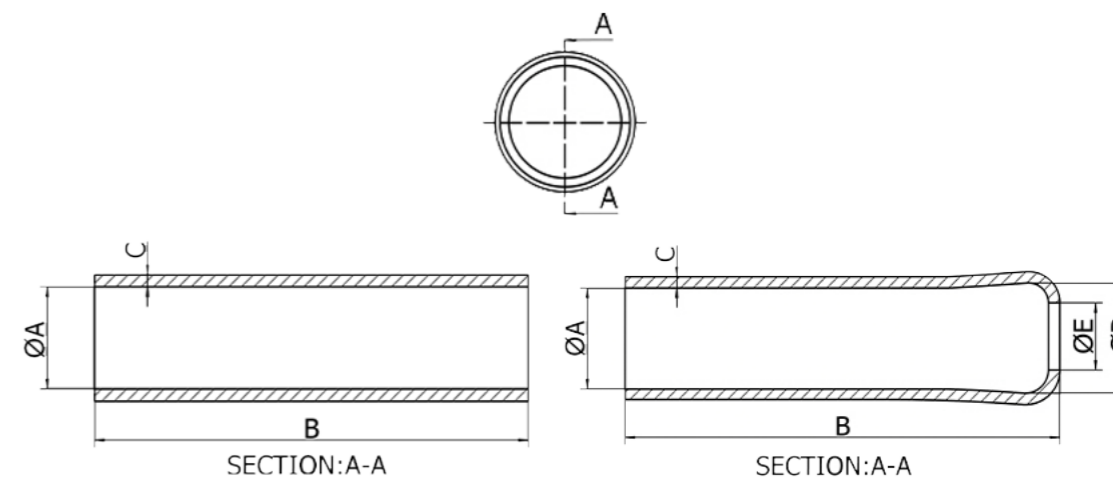



PLASTIC SPIRAL WRAP PROTECTOR



DME & JDE GROUP
YOUR CONNECTORS & HOSES OEM SOLUTIONS

Protection From Abrasion, Shocks & Rubbing

DME&JDE

Protection From Abrasion, Shocks & Rubbing

Texture

The material is PP polypropylene, all PP polypropylene raw materials produced by Sinopec Company.

Features

Wear-resistant, beautiful, flame retardant, oil resistance, anti-freeze, aging resistance, corrosion resistance, high and low temperature resistance (-40°C to 80°C).



Hose assembly parts, during operation, can reduce the impact of various internal and external operating conditions on rubber hoses, including preventing the rubber hose from whipping when working under high pressure, mitigating hose abrasion in construction sites, mines or quarries and hose corrosion caused by seawater during ship traveling on the sea. Hose assembly parts help to limit the movement range of the hose and extend the lifespan of the hose.

DME&JDE Hydraulic Hose Protective Spiral Wrap

- Flat Surface Plastic Spiral Warp Protector



DME&JDE flat surface plastic spiral warp protector, as its name implies, is a kind of spiral hose guard with a flat surface that protects the internal hydraulic hose under various harsh conditions to ensure the safety of construction and prolong the service life of the hydraulic hose.

DME&JDE Hydraulic Hose Protective Spiral Wrap

- Cambered Surface Plastic Spiral Warp Protector



DME&JDE cambered surface plastic spiral warp protector, as its name implies, is a kind of spiral hose guard with a cambered surface and the edge thickness is thinner than that of the center. When the cambered surface and the flat surface plastic spiral warp protector have the same inner diameter, their center thickness is also the same. If you do not want your hose to add more weight, you may choose cambered surface plastic spiral warp protector.

DME&JDE

Protection From Abrasion, Shocks & Rubbing



Material & Features & Benefits

- Polypropylene (PP).
- Exceptional anti-crushing performance. [AS 1145:Test passed].
- High abrasion resistance. [ISO 6954:Test passed].
- Long life & Good resistance to UV rays. [ISO 4892-2 :Test passed]
- Fire Resistance / Flame retardant [ISO 1210 :Test passed]
- Easy to fit.



Specification of Flat Surface Plastic Spiral Warp Protector						
Type (mm)	I.D. (mm)	O.D. (mm)	W. (mm)	P. (mm)	Recommended Hose Range (mm)	Length (m/roll)
D&J-HDPE-1-8	8.0	10.0	1.0	12.0	8-12	2/20/50/100/200
D&J-HDPE-1-10	10.0	12.0	1.0	12.0	10-14	2/20/50/100/200
D&J-HDPE-1-12	12.0	14.0	1.0	12.0	12-16	2/20/50/100/200
D&J-HDPE-1-14	14.0	16.0	1.0	13.0	14-18	2/20/50/100/200
D&J-HDPE-1-16	16.0	18.8	1.4	14.5	16-20	2/20/50/100/200
D&J-HDPE-1-18	18.0	21.2	1.6	15.5	18-22	2/20/50/100
D&J-HDPE-1-19	19.0	22.2	1.6	15.5	19-22	2/20/50/100
D&J-HDPE-1-21	21.0	24.6	1.8	18.5	21-25	2/20/50/100
D&J-HDPE-1-22	22.0	25.6	1.8	18.5	22-25	2/20/50/100
D&J-HDPE-1-25	25.0	28.6	1.8	21.5	25-30	2/20/50/100/150
D&J-HDPE-1-26	26.0	29.6	1.8	21.5	26-30	2/20/50/100/150
D&J-HDPE-1-28	28.0	31.8	1.9	22.5	28-32	2/20/50/100/150
D&J-HDPE-1-30	30.0	34.0	2.0	23.0	30-35	2/20/50/100
D&J-HDPE-1-32	32.0	36.0	2.0	23.0	32-38	2/20/50/100
D&J-HDPE-1-35	35.0	39.0	2.0	24.0	35-40	2/20/50/100
D&J-HDPE-1-38	38.0	42.0	2.0	24.0	38-43	2/20/50/100
D&J-HDPE-1-40	40.0	45.6	2.8	25.0	40-45	2/20/50
D&J-HDPE-1-42	42.0	48.0	3.0	26.0	42-48	2/20/50
D&J-HDPE-1-45	45.0	51.0	3.0	27.0	45-50	2/20/50
D&J-HDPE-1-48	48.0	54.0	3.0	27.0	48-52	2/20/50
D&J-HDPE-1-50	50.0	56.0	3.0	27.0	50-55	2/20/50
D&J-HDPE-1-51	51.0	57.0	3.0	27.0	51-56	2/20/50
D&J-HDPE-1-60	60.0	66.0	3.0	26.5	60-65	2/20/50
D&J-HDPE-1-63	63.0	69.0	3.0	27.0	63-70	2/20/50
D&J-HDPE-1-68	68.0	74.0	3.0	30.0	68-72	2/20/50
D&J-HDPE-1-74	74.0	84.4	5.2	47.5	74-80	2/10/20
D&J-HDPE-1-80	80.0	89.0	4.5	40.5	80-85	2/10
D&J-HDPE-1-88	88.0	98.0	5.0	43.0	88-95	2/10
D&J-HDPE-1-100	100.0	110.0	5.0	45.0	100-110	2/10

DME&JDE Hydraulic Hose Protective Spiral Wrap

- Cambered Surface Plastic Spiral Warp Protector



Material & Features & Benefits

- Polypropylene (PP).
- Exceptional anti-crushing performance. [AS 1145:Test passed].
- High abrasion resistance. [ISO 6954:Test passed].
- Long life & Good resistance to UV rays. [ISO 4892-2 :Test passed]
- Fire Resistance / Flame retardant [ISO 1210 :Test passed]
- Easy to fit.



Specification of Cambered Surface Plastic Spiral Warp Protector						
Type (mm)	I.D. (mm)	O.D. (mm)	W (mm)	P (mm)	Recommended Hose Range (mm)	Length (m/roll)
D&J-HDPE-2-8	8.0	11.0	1.5	10.0	8/12	2/20/50/100/200
D&J-HDPE-2-10	10.0	12.8	1.4	11.0	10/14	2/20/50/100/200
D&J-HDPE-2-12	12.0	15.0	1.5	12.0	12/16	2/20/50/100/200
D&J-HDPE-2-14	14.0	17.0	1.5	13.0	14-18	2/20/50/100/200
D&J-HDPE-2-16	16.0	19.6	1.8	15.0	16-20	2/20/50/100/200
D&J-HDPE-2-18	18.0	21.6	1.8	16.0	18-22	2/20/50/100
D&J-HDPE-2-20	20.0	24.0	2.0	18.0	20-24	2/20/50/100
D&J-HDPE-2-21	21.0	25.0	2.0	18.0	21-25	2/20/50/100
D&J-HDPE-2-22	22.0	26.0	2.0	18.0	22-25	2/20/50/100
D&J-HDPE-2-23	23.0	27.0	2.0	19.2	23-28	2/20/50/100/150
D&J-HDPE-2-24	24.0	28.0	2.0	21.0	24-28	2/20/50/100/150
D&J-HDPE-2-25	25.0	29.8	2.4	21.5	25-30	2/20/50/100/150
D&J-HDPE-2-28	28.0	33.2	2.6	23.0	28-32	2/20/50/100/150
D&J-HDPE-2-30	30.0	34.8	2.4	22.5	30-35	2/20/50/100
D&J-HDPE-2-32	32.0	37.6	2.8	23.0	32-38	2/20/50/100
D&J-HDPE-2-35	35.0	40.6	2.8	24.0	35-40	2/20/50/100
D&J-HDPE-2-38	38.0	44.0	3.0	25.0	38-43	2/20/50/100
D&J-HDPE-2-40	40.0	47.0	3.5	27.0	40-45	2/20/50
D&J-HDPE-2-42	42.0	49.0	3.5	25.0	42-48	2/20/50
D&J-HDPE-2-45	45.0	53.0	4.0	28.0	45-50	2/20/50
D&J-HDPE-2-48	48.0	56.0	4.0	28.0	48-52	2/20/50
D&J-HDPE-2-50	50.0	59.0	4.5	29.0	50-55	2/20/50
D&J-HDPE-2-52	52.0	61.0	4.5	29.0	52-58	2/20/50
D&J-HDPE-2-55	55.0	64.0	4.5	30.0	55-60	2/20/50
D&J-HDPE-2-60	60.0	69.0	4.5	30.0	60-65	2/20/50
D&J-HDPE-2-63	63.0	72.0	4.5	30.0	63-68	2/20/50
D&J-HDPE-2-65	65.0	74.0	4.5	30.0	65-70	2/20/50
D&J-HDPE-2-67	67.0	76.0	4.5	30.0	67-72	2/10/20
D&J-HDPE-2-70	70.0	79.0	4.5	34.0	70-75	2/10/20
D&J-HDPE-2-74	74.0	84.0	5.0	34.0	74-80	2/10
D&J-HDPE-2-75	75.0	85.0	5.0	42.0	75-78	2/10
D&J-HDPE-2-80	80.0	91.0	5.5	45.0	80-85	2/10
D&J-HDPE-2-88	88.0	99.0	5.5	45.0	88-95	2/10
D&J-HDPE-2-90	90.0	101.0	5.5	45.0	90-97	2/10
D&J-HDPE-2-100	100.0	112.0	6.0	50.0	100-110	2/10
D&J-HDPE-2-150	150.0	162.0	6.0	38.0	150-180	2
D&J-HDPE-2-200	200.0	210.0	5.0	50.0	200-300	2



Industry MSHA
Industry MSHA



Nylon Sleeve

-  SHIELD-FLEX
-  EXACT-FLEX
-  EASY-FIT
EASY-FLEX





DME&JDE Shield-Flex Nylon Sleeve

Shield-Flex nylon sleeve Protects people near-by a breaking hose (pin hole-approved) or Hydraulic Hose. It is produced from polypropylene which is very hard-wearing.

- Material polypropylene (PP)
- UV protected
- Resistant to acids, oil and solvents
- Pin-hole protection ISO 3457 and ISO 4413
- Abrasion resistance 50,000 cycles
- Temperature range is -40 °C to +80 °C
- Colour: black

Remark: It is recommended to choose a size which is approximately 50 % larger than the hose to improve protection and make mounting easier.



Why Shield-Flex Nylon-Sleeve?

European standard EN ISO 3457 states that hydraulic hoses must be protected in following cases:

- Operating pressure exceeds 5 MPa (=50 bar)
- Or temperature exceeds 60 °C
- And the hoses are in common operating place within 1 meter range from the operator and in case of hose breakage the direct fluid spray may reach the operator

In addition, the protectors must be strong enough to stop, spread or turn the fluid from directly hitting the operator once the hose breaks.

Standards EN 12999 and EN 4413 also contain protection demands for hose assemblies.

Our Safe-Sleeve fulfills these demands:

- Our standard textile sleeve
- Economical and safe choice for hose protection
- Protect people near-by a breaking hose
- Protect hydraulic hoses from abrasion
- Produced from polypropylene which is very hard-wearing and recyclable
- Endure acids and alkali well
- Material fully recyclable
- Tolerate both freeze and heat
- Recommended temperature range from -40 °C to + 80 °C
- UV-protected
- Excellent abrasion resistance



Specifications

Available Colors

- Standard color is plain black, no printing.
- Other colors also possible (MOQ 1000–2000 m per size).

Available Sizes and Lengths

Available in inner diameters from 10 mm to 125 mm. It is recommended to choose a size which is a few millimetres larger than the hose to improve protection and make mounting easier. Whether there is a coupling already installed also affects the eligible size. Available in rolls of 50 m or pre-cut lengths in OEM request.



Table 1: Shield-Flex Nylon Sleeve Specifications

Part No.	I.D. (mm)	Width (mm)	Wall Thickness (mm)	Roll Length (Meters)	MOQ (Meters)	Color
D&J-NYLON-010	10	20	1	50	1000	Black
D&J-NYLON-015	15	25	1	50	1000	Black
D&J-NYLON-017	17	30	1	50	1000	Black
D&J-NYLON-020	20	35	1	50	1000	Black
D&J-NYLON-026	26	45	1	50	1000	Black
D&J-NYLON-027	27	45	1	50	1000	Black
D&J-NYLON-029	29	50	1	50	1000	Black
D&J-NYLON-030	30	50	1	50	1000	Black
D&J-NYLON-036	36	60	1	50	1000	Black
D&J-NYLON-039	39	65	1	50	1000	Black
D&J-NYLON-042	42	70	1	50	1000	Black
D&J-NYLON-046	46	75	1	50	1000	Black
D&J-NYLON-048	48	80	1	50	200	Black
D&J-NYLON-055	55	90	1	50	200	Black
D&J-NYLON-062	62	100	1	50	200	Black
D&J-NYLON-078	78	125	1	50	200	Black
D&J-NYLON-094	94	150	1	50	200	Black
D&J-NYLON-109	109	175	1	50	200	Black
D&J-NYLON-125	125	200	1	50	200	Black

Selection guide

Table 2: Selection Guide of Shield-Flex Nylon Sleeve

Part No.	Safe-Sleeve ID (mm)	Hose DN (mm)	Standard (BS EN)	Hose DN (inch)	Hose OD (mm)
D&J-NYLON-017	17	6	EN853 2SN	1/4"	14.9
D&J-NYLON-023	23	8	EN853 2SN	5/16"	16.3
D&J-NYLON-027	27	10	EN853 2SN	3/8"	18.8
D&J-NYLON-030	30	13	EN853 2SN	1/2"	22.2
D&J-NYLON-036	36	16	EN853 2SN	5/8"	25.4
D&J-NYLON-039	39	19	EN853 2SN	3/4"	29.4
D&J-NYLON-046	46	25	EN853 2SN	1"	37.0
D&J-NYLON-055	55	32	EN853 2SN	1-1/4"	46.5
D&J-NYLON-062	62	38	EN853 2SN	1-1/2"	53.3
D&J-NYLON-078	78	51	EN853 2SN	2"	66.5
D&J-NYLON-094	94	–	–	–	–
D&J-NYLON-109	109	100	–	–	–
D&J-NYLON-125	125	115	–	–	–

Accessories

Aluminum rings

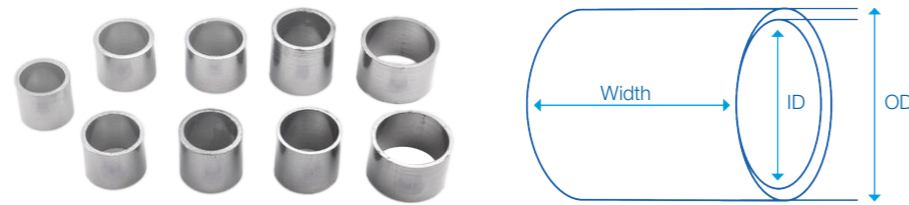

Table 3: Aluminum Rings Specifications

Safeplast Article No.	OD	ID	W	Width
	mm	mm	mm	mm
D&J-ALRing-20	20	17	1.5	27
D&J-ALRing-25	25	22	1.5	27
D&J-ALRing-30	30	27	1.5	27
D&J-ALRing-35	35	32	1.5	27
D&J-ALRing-40	40	36	2	30
D&J-ALRing-45	45	41	2	30
D&J-ALRing-50	50	46	2	30
D&J-ALRing-55	55	51	2	30

Hose clamp

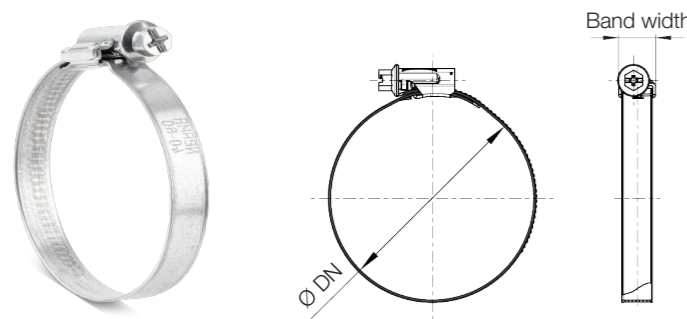

Table 4: Hose Clamp Materials

Part	W1	W2	W3	W4	W5
Hose Clamp Band & Accessory	Galvanized Steel	Stainless steel AISI 430	Stainless steel AISI 430	Stainless steel AISI 304	Stainless steel AISI 316
Screw & Lock Washer	Galvanized Steel	Galvanized low carbon steel	Stainless steel AISI 403	Stainless steel AISI 304	Stainless steel AISI 316



Table 5: Hose Clamp Specifications

Band Width mm	Description	Gripping Range DN (mm)	DME&JDE Group Code					Package Qty. pcs
			W1	W2	W3	W4	W5	
7.5	SHIELD-FLEX® 8-12	8-12	-	0116*7602*010	0116*7603*010	-	-	100
7.5	SHIELD-FLEX® 10-16	10-16	-	0116*7602*013	0116*7603*013	-	-	100
7.5	SHIELD-FLEX® 12-18	12-18	-	0116*7602*015	0116*7603*015	-	-	100
7.5	SHIELD-FLEX® 12-22	12-22	-	0116*7602*017	0116*7603*017	-	-	100
7.5	SHIELD-FLEX® 16-27	16-27	-	0116*7602*021	0116*7603*021	-	-	100
9	SHIELD-FLEX® 8-12	8-12	0126*7565*010	0126*7702*010	0126*7703*010	0126*7704*010	-	100
9	SHIELD-FLEX® 10-16	10-16	0126*7565*013	0126*7702*013	0126*7703*013	0126*7704*013	0126*7705*013	100
9	SHIELD-FLEX® 12-22	12-22	0126*7565*017	0126*7702*017	0126*7703*017	0126*7704*017	0126*7705*017	100
9	SHIELD-FLEX® 16-27	16-27	0126*7565*021	0126*7702*021	0126*7703*021	0126*7704*021	0126*7705*021	100
9	SHIELD-FLEX® 20-32	20-32	0126*7565*026	0126*7702*026	0126*7703*026	0126*7704*026	0126*7705*026	100
9	SHIELD-FLEX® 25-40	25-40	0126*7565*032	0126*7702*032	0126*7703*032	0126*7704*032	0126*7705*032	100
9	SHIELD-FLEX® 30-45	30-45	0126*7565*037	0126*7702*037	0126*7703*037	0126*7704*037	0126*7705*037	100
9	SHIELD-FLEX® 35-50 (32-50)	35-50	0126*7565*043	0126*7702*041	0126*7703*041	0126*7704*041	0126*7705*041	50
9	SHIELD-FLEX® 40-60	40-60	0126*7565*050	0126*7702*050	0126*7703*050	0126*7704*050	0126*7705*050	50
9	SHIELD-FLEX® 50-70	50-70	0126*7565*060	0126*7702*060	0126*7703*060	0126*7704*060	0126*7705*060	50
9	SHIELD-FLEX® 60-80	60-80	0126*7565*070	0126*7702*070	0126*7703*070	0126*7704*070	0126*7705*070	25
9	SHIELD-FLEX® 70-90	70-90	0126*7565*080	0126*7702*080	0126*7703*080	0126*7704*080	0126*7705*080	25
9	SHIELD-FLEX® 80-100	80-100	0126*7565*090	0126*7702*090	0126*7703*090	0126*7704*090	0126*7705*090	25
9	SHIELD-FLEX® 90-110	90-110	0126*7565*100	0126*7702*100	0126*7703*100	0126*7704*100	0126*7705*100	25
9	SHIELD-FLEX® 100-120	100-120	0126*6565*110	0126*6702*110	0126*6703*110	0126*6704*110	0126*6705*110	25
9	SHIELD-FLEX® 110-130	110-130	0126*6565*120	0126*6702*120	0126*6703*120	0126*6704*120	0126*6705*120	25
9	SHIELD-FLEX® 120-140	120-140	0126*6565*130	0126*6702*130	0126*6703*130	0126*6704*130	0126*6705*130	25
9	SHIELD-FLEX® 130-150	130-150	0126*6565*140	0126*6702*140	0126*6703*140	0126*6704*140	0126*6705*140	25
9	SHIELD-FLEX® 140-160	140-160	0126*6565*150	0126*6702*150	0126*6703*150	0126*6704*150	0126*6705*150	25
12	SHIELD-FLEX® 16-27	16-27	0136*7352*021	0136*7702*021	0136*7703*021	0136*7704*021	0136*7705*021	50
12	SHIELD-FLEX® 20-32	20-32	0136*7352*026	0136*7702*026	0136*7703*026	0136*7704*026	0136*7705*026	50
12	SHIELD-FLEX® 25-40	25-40	0136*7352*032	0136*7702*032	0136*7703*032	0136*7704*032	0136*7705*032	50
12	SHIELD-FLEX® 30-45	30-45	0136*7352*037	0136*7702*037	0136*7703*037	0136*7704*037	0136*7705*037	50
12	SHIELD-FLEX® 35-50	35-50	0136*7352*043	0136*7702*043	0136*7703*043	0136*7704*043	0136*7705*043	50
12	SHIELD-FLEX® 40-60	40-60	0136*7352*050	0136*7702*050	0136*7703*050	0136*7704*050	0136*7705*050	25
12	SHIELD-FLEX® 50-70	50-70	0136*7352*060	0136*7702*060	0136*7703*060	0136*7704*060	0136*7705*060	25
12	SHIELD-FLEX® 60-80	60-80	0136*7352*070	0136*7702*070	0136*7703*070	0136*7704*070	0136*7705*070	25
12	SHIELD-FLEX® 70-90	70-90	0136*7352*080	0136*7702*080	0136*7703*080	0136*7704*080	0136*7705*080	25
12	SHIELD-FLEX® 80-100	80-100	0136*7352*090	0136*7702*090	0136*7703*090	0136*7704*090	0136*7705*090	25
12	SHIELD-FLEX® 90-110	90-110	0136*7352*100	0136*7702*100	0136*7703*100	0136*7704*100	0136*7705*100	25
12	SHIELD-FLEX® 100-120	100-120	0136*6352*110	0136*6702*110	0136*6703*110	0136*6704*110	0136*6705*110	20
12	SHIELD-FLEX® 110-130	110-130	0136*6352*120	0136*6702*120	0136*6703*120	0136*6704*120	0136*6705*120	20
12	SHIELD-FLEX® 120-140	120-140	0136*6352*130	0136*6702*130	0136*6703*130	0136*6704*130	0136*6705*130	20
12	SHIELD-FLEX® 130-150	130-150	0136*6352*140	0136*6702*140	0136*6703*140	0136*6704*140	0136*6705*140	20
12	SHIELD-FLEX® 140-160	140-160	0136*6352*150	0136*6702*150	0136*6703*150	0136*6704*150	0136*6705*150	20



DME&JDE Exact-Flex Flame Retardant Textile Sleeve

EXACT-FLEX Flame retardant textile sleeve is made with an extremely durable and flexible nylon which provides protection against abrasion or degradation.

- Material: polyester (PES) or nylon (PA)
- UV -tolerant
- Resistant to acids, oil and solvents
- Abrasion resistance > 100 000 cycles
- Pin-hole protection ISO 3457 and ISO 4413
- Temperature range: -40 °C to +120 °C
- Color: black, other colours available on request
- OEM Serve with white printing



Why Exact-Flex Flame Retardant Textile Sleeve?

Exact-Flex flame retardant textile sleeve is a textile hose protector which is produced from recyclable polyester. It is easy to install and its abrasion resistance is excellent. In addition to protecting hoses, EXACT-FLEX flame retardant textile sleeve protects people nearby a breaking hose and meets the requirements of standards EN ISO 3457, EN 4413 and EN 12999. Test reports are available on request.

Exact-Flex Flame retardant textile sleeve Features

- Flame retardant
- Economical and safe choice for hose protection
- Protect people near-by a breaking hose
- Protect hydraulic hoses from abrasion
- Produced from polyester, very hard-wearing and recyclable
- Endure acids and alkali well
- Material fully recyclable
- Tolerate both freeze and heat
- Recommended temperature range from -50 °C to +140 °C
- UV-tolerant
- Excellent abrasion resistance



Specifications

Available Colors

Black with white printing only. Own printing possible (MOQ apply)

Available Sizes and Lengths

- Available in inner diameters from 17 mm to 125 mm.
- Available in rolls of 50 m or pre-cut lengths.

Table 1: Exact-Flex Flame Retardant Textile Sleeve Specifications

Part No.	I.D. (mm)	Width (mm)	Wall Thickness (mm)	Roll Length (Meters)	MOQ (Meters)	Color
D&J-FLAME-010	10	20	1	50	1000	Black
D&J-FLAME-015	15	25	1	50	1000	Black
D&J-FLAME-017	17	30	1	50	1000	Black
D&J-FLAME-020	20	35	1	50	1000	Black
D&J-FLAME-026	26	45	1	50	1000	Black
D&J-FLAME-027	27	45	1	50	1000	Black
D&J-FLAME-029	29	50	1	50	1000	Black
D&J-FLAME-030	30	50	1	50	1000	Black
D&J-FLAME-036	36	60	1	50	1000	Black
D&J-FLAME-039	39	65	1	50	1000	Black
D&J-FLAME-042	42	70	1	50	1000	Black
D&J-FLAME-046	46	75	1	50	1000	Black
D&J-FLAME-048	48	80	1	50	200	Black
D&J-FLAME-055	55	90	1	50	200	Black
D&J-FLAME-062	62	100	1	50	200	Black
D&J-FLAME-078	78	125	1	50	200	Black
D&J-FLAME-094	94	150	1	50	200	Black
D&J-FLAME-109	109	175	1	50	200	Black
D&J-FLAME-125	125	200	1	50	200	Black

Selection guide



Table 2: Selection Guide of Exact-Flex Flame Retardant Textile Sleeve

Part No.	Safe-Sleeve ID (mm)	Hose DN (mm)	Standard (BS EN)	Hose DN (inch)	Hose OD (mm)
D&J-NYLON-017	17	6	EN853 2SN	1/4"	14.9
D&J-NYLON-023	23	8	EN853 2SN	5/16"	16.3
D&J-NYLON-027	27	10	EN853 2SN	3/8"	18.8
D&J-NYLON-030	30	13	EN853 2SN	1/2"	22.2
D&J-NYLON-036	36	16	EN853 2SN	5/8"	25.4
D&J-NYLON-039	39	19	EN853 2SN	3/4"	29.4
D&J-NYLON-046	46	25	EN853 2SN	1"	37.0
D&J-NYLON-055	55	32	EN853 2SN	1-1/4"	46.5
D&J-NYLON-062	62	38	EN853 2SN	1-1/2"	53.3
D&J-NYLON-078	78	51	EN853 2SN	2"	66.5
D&J-NYLON-094	94	-	-	-	-
D&J-NYLON-109	109	100	-	-	-
D&J-NYLON-125	125	115	-	-	-

Accessories

Aluminum rings

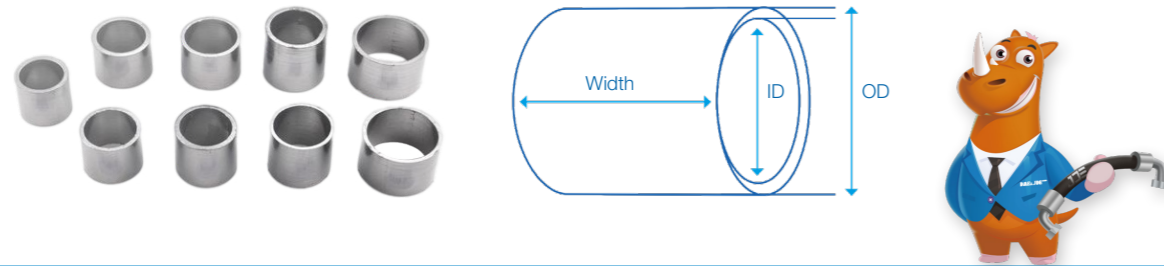

Table 3: Aluminum Rings Specifications

Safeplast Article No.	OD	ID	W	Width
	mm	mm	mm	mm
D&J-ALRing-20	20	17	1.5	27
D&J-ALRing-25	25	22	1.5	27
D&J-ALRing-30	30	27	1.5	27
D&J-ALRing-35	35	32	1.5	27
D&J-ALRing-40	40	36	2	30
D&J-ALRing-45	45	41	2	30
D&J-ALRing-50	50	46	2	30
D&J-ALRing-55	55	51	2	30



Hose clamp

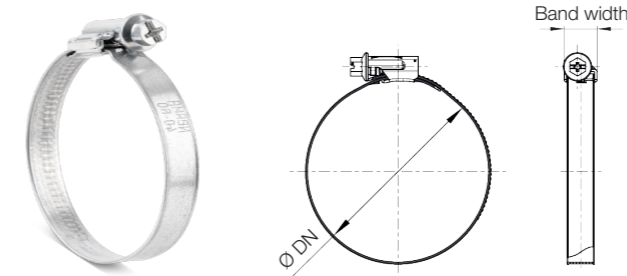

Table 4: Hose Clamp Materials

Part	W1	W2	W3	W4	W5
Hose Clamp Band & Accessory	Galvanized Steel	Stainless steel AISI 430	Stainless steel AISI 430	Stainless steel AISI 304	Stainless steel AISI 316
Screw & Lock Washer	Galvanized Steel	Galvanized low carbon steel	Stainless steel AISI 403	Stainless steel AISI 304	Stainless steel AISI 316

Table 5: Hose Clamp Specifications

Band Width mm	Description	Gripping Range DN (mm)	DME&JDE Group Code					Package Qty. pcs
			W1	W2	W3	W4	W5	
7.5	SHIELD-FLEX® 8-12	8-12	-	0116*7602*010	0116*7603*010	-	-	100
7.5	SHIELD-FLEX® 10-16	10-16	-	0116*7602*013	0116*7603*013	-	-	100
7.5	SHIELD-FLEX® 12-18	12-18	-	0116*7602*015	0116*7603*015	-	-	100
7.5	SHIELD-FLEX® 12-22	12-22	-	0116*7602*017	0116*7603*017	-	-	100
7.5	SHIELD-FLEX® 16-27	16-27	-	0116*7602*021	0116*7603*021	-	-	100
9	SHIELD-FLEX® 8-12	8-12	0126*7565*010	0126*7702*010	0126*7703*010	0126*7704*010	-	100
9	SHIELD-FLEX® 10-16	10-16	0126*7565*013	0126*7702*013	0126*7703*013	0126*7704*013	0126*7705*013	100
9	SHIELD-FLEX® 12-22	12-22	0126*7565*017	0126*7702*017	0126*7703*017	0126*7704*017	0126*7705*017	100
9	SHIELD-FLEX® 16-27	16-27	0126*7565*021	0126*7702*021	0126*7703*021	0126*7704*021	0126*7705*021	100
9	SHIELD-FLEX® 20-32	20-32	0126*7565*026	0126*7702*026	0126*7703*026	0126*7704*026	0126*7705*026	100
9	SHIELD-FLEX® 25-40	25-40	0126*7565*032	0126*7702*032	0126*7703*032	0126*7704*032	0126*7705*032	100
9	SHIELD-FLEX® 30-45	30-45	0126*7565*037	0126*7702*037	0126*7703*037	0126*7704*037	0126*7705*037	100
9	SHIELD-FLEX® 35-50 (32-50)	35-50	0126*7565*043	0126*7702*041	0126*7703*041	0126*7704*041	0126*7705*041	50
9	SHIELD-FLEX® 40-60	40-60	0126*7565*050	0126*7702*050	0126*7703*050	0126*7704*050	0126*7705*050	50
9	SHIELD-FLEX® 50-70	50-70	0126*7565*060	0126*7702*060	0126*7703*060	0126*7704*060	0126*7705*060	50
9	SHIELD-FLEX® 60-80	60-80	0126*7565*070	0126*7702*070	0126*7703*070	0126*7704*070	0126*7705*070	25
9	SHIELD-FLEX® 70-90	70-90	0126*7565*080	0126*7702*080	0126*7703*080	0126*7704*080	0126*7705*080	25
9	SHIELD-FLEX® 80-100	80-100	0126*7565*090	0126*7702*090	0126*7703*090	0126*7704*090	0126*7705*090	25
9	SHIELD-FLEX® 90-110	90-110	0126*7565*100	0126*7702*100	0126*7703*100	0126*7704*100	0126*7705*100	25
9	SHIELD-FLEX® 100-120	100-120	0126*6565*110	0126*6702*110	0126*6703*110	0126*6704*110	0126*6705*110	25
9	SHIELD-FLEX® 110-130	110-130	0126*6565*120	0126*6702*120	0126*6703*120	0126*6704*120	0126*6705*120	25
9	SHIELD-FLEX® 120-140	120-140	0126*6565*130	0126*6702*130	0126*6703*130	0126*6704*130	0126*6705*130	25
9	SHIELD-FLEX® 130-150	130-150	0126*6565*140	0126*6702*140	0126*6703*140	0126*6704*140	0126*6705*140	25
9	SHIELD-FLEX® 140-160	140-160	0126*6565*150	0126*6702*150	0126*6703*150	0126*6704*150	0126*6705*150	25
12	SHIELD-FLEX® 16-27	16-27	0136*7352*021	0136*7702*021	0136*7703*021	0136*7704*021	0136*7705*021	50
12	SHIELD-FLEX® 20-32	20-32	0136*7352*026	0136*7702*026	0136*7703*026	0136*7704*026	0136*7705*026	50
12	SHIELD-FLEX® 25-40	25-40	0136*7352*032	0136*7702*032	0136*7703*032	0136*7704*032	0136*7705*032	50
12	SHIELD-FLEX® 30-45	30-45	0136*7352*037	0136*7702*037	0136*7703*037	0136*7704*037	0136*7705*037	50
12	SHIELD-FLEX® 35-50	35-50	0136*7352*043	0136*7702*043	0136*7703*043	0136*7704*043	0136*7705*043	50
12	SHIELD-FLEX® 40-60	40-60	0136*7352*050	0136*7702*050	0136*7703*050	0136*7704*050	0136*7705*050	25
12	SHIELD-FLEX® 50-70	50-70	0136*7352*060	0136*7702*060	0136*7703*060	0136*7704*060	0136*7705*060	25
12	SHIELD-FLEX® 60-80	60-80	0136*7352*070	0136*7702*070	0136*7703*070	0136*7704*070	0136*7705*070	25
12	SHIELD-FLEX® 70-90	70-90	0136*7352*080	0136*7702*080	0136*7703*080	0136*7704*080	0136*7705*080	25
12	SHIELD-FLEX® 80-100	80-100	0136*7352*090	0136*7702*090	0136*7703*090	0136*7704*090	0136*7705*090	25
12	SHIELD-FLEX® 90-110	90-110	0136*7352*100	0136*7702*100	0136*7703*100	0136*7704*100	0136*7705*100	25
12	SHIELD-FLEX® 100-120	100-120	0136*6352*110	0136*6702*110	0136*6703*110	0136*6704*110	0136*6705*110	20
12	SHIELD-FLEX® 110-130	110-130	0136*6352*120	0136*6702*120	0136*6703*120	0136*6704*120	0136*6705*120	20
12	SHIELD-FLEX® 120-140	120-140	0136*6352*130	0136*6702*130	0136*6703*130	0136*6704*130	0136*6705*130	20
12	SHIELD-FLEX® 130-150	130-150	0136*6352*140	0136*6702*140	0136*6703*140	0136*6704*140	0136*6705*140	20
12	SHIELD-FLEX® 140-160	140-160	0136*6352*150	0136*6702*150	0136*6703*150	0136*6704*150	0136*6705*150	20

DME&JDE Easy-Flex Velcro Sleeve



Easy-Flex Velcro Sleeve is produced from polyamide with Polyester and nylon Velcro fasteners which make it very easy and fast to install on hose assemblies afterwards and repeatedly.

- Material: Polyester and nylon Velcro
- UV protected
- Resistant to acids, oil and solvents
- Pin-hole protection ISO 3457 and ISO 4413
- Abrasion resistance: >100 000 cycles
- Temperature range: -20 °C to +180 °C
- Color: black



Why Easy-Flex Velcro Sleeve?

Easy-Flex Velcro Sleeve is very easy and fast to install on hose assemblies afterwards and repeatedly. This makes it a very cost-effective solution for hose protection and hose bundling.

This product is tailor-made and we can offer you different solutions by adding for example mounting eyelets and / or bundling straps.

Easy-Flex Velcro Sleeve Features

- 100% Polyamide with PU coating and Velcro type fasteners
- Fulfill the demands of standard ISO 3457 (pin hole -approved)
- Excellent tensile strength (EN ISO 13934-1)
- Water repellence of the fabric is 100 % (EN 24920)
- Abrasion resistant
- Recommended temperature range from -20 °C to +120 °C



Specifications

Available Colors

Black with white printing only. Own printing possible (MOQ apply)

Available Sizes and Lengths

- Standard diameters ID: 20 mm, 40 mm, 50 mm, 60 mm, 80 mm, 100 mm, 120 mm and 150 mm.
- Other diameters (from ID 20 mm to 400 mm in 5 mm intervals) are available on request
- Standard roll lengths are 10 m and 25 m. Other roll lengths up to 50 m and all fixed lengths (MOQ apply) are produced after order.

Table 1: Easy-Flex Velcro Sleeve Specifications

Part No.	I.D. (mm)	Width (mm)	Wall Thickness (mm)	Roll Length (Meters)	MOQ (Meters)	Color
D&J-VELCRO-017	16	17	1	50	500	Black
D&J-VELCRO-020	20	22	1	50	500	Black
D&J-VELCRO-026	25	27	1	50	500	Black
D&J-VELCRO-027	30	32	1	50	500	Black
D&J-VELCRO-029	35	37	1	50	500	Black
D&J-VELCRO-030	40	42	1	50	500	Black
D&J-VELCRO-036	45	47	1	50	500	Black
D&J-VELCRO-039	50	52	1	50	500	Black
D&J-VELCRO-042	55	57	1	50	500	Black
D&J-VELCRO-046	60	62	1	50	500	Black
D&J-VELCRO-048	65	67	1	50	500	Black

Web: <https://www.dmejde.com>
E-mail: info@dmejde.com



Accessories

Hose clamp

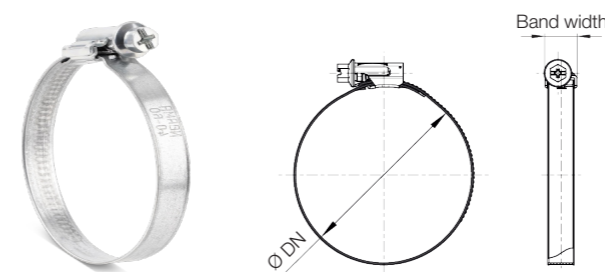

Table 2: Hose Clamp Materials

Part	W1	W2	W3	W4	W5
Hose Clamp Band & Accessory	Galvanized Steel	Stainless steel AISI 430	Stainless steel AISI 430	Stainless steel AISI 304	Stainless steel AISI 316
Screw & Lock Washer	Galvanized Steel	Galvanized low carbon steel	Stainless steel AISI 403	Stainless steel AISI 304	Stainless steel AISI 316

Table 3: Hose Clamp Specifications

Band Width mm	Description	Gripping Range DN (mm)	DME&JDE Group Code					Package Qty. pcs
			W1	W2	W3	W4	W5	
7.5	SHIELD-FLEX® 8–12	8–12	–	0116*7602*010	0116*7603*010	–	–	100
7.5	SHIELD-FLEX® 10–16	10–16	–	0116*7602*013	0116*7603*013	–	–	100
7.5	SHIELD-FLEX® 12–18	12–18	–	0116*7602*015	0116*7603*015	–	–	100
7.5	SHIELD-FLEX® 12–22	12–22	–	0116*7602*017	0116*7603*017	–	–	100
7.5	SHIELD-FLEX® 16–27	16–27	–	0116*7602*021	0116*7603*021	–	–	100
9	SHIELD-FLEX® 8–12	8–12	0126*7565*010	0126*7702*010	0126*7703*010	0126*7704*010	–	100
9	SHIELD-FLEX® 10–16	10–16	0126*7565*013	0126*7702*013	0126*7703*013	0126*7704*013	0126*7705*013	100
9	SHIELD-FLEX® 12–22	12–22	0126*7565*017	0126*7702*017	0126*7703*017	0126*7704*017	0126*7705*017	100
9	SHIELD-FLEX® 16–27	16–27	0126*7565*021	0126*7702*021	0126*7703*021	0126*7704*021	0126*7705*021	100
9	SHIELD-FLEX® 20–32	20–32	0126*7565*026	0126*7702*026	0126*7703*026	0126*7704*026	0126*7705*026	100
9	SHIELD-FLEX® 25–40	25–40	0126*7565*032	0126*7702*032	0126*7703*032	0126*7704*032	0126*7705*032	100
9	SHIELD-FLEX® 30–45	30–45	0126*7565*037	0126*7702*037	0126*7703*037	0126*7704*037	0126*7705*037	100
9	SHIELD-FLEX® 35–50 (32–50)	35–50	0126*7565*043	0126*7702*041	0126*7703*041	0126*7704*041	0126*7705*041	50
9	SHIELD-FLEX® 40–60	40–60	0126*7565*050	0126*7702*050	0126*7703*050	0126*7704*050	0126*7705*050	50
9	SHIELD-FLEX® 50–70	50–70	0126*7565*060	0126*7702*060	0126*7703*060	0126*7704*060	0126*7705*060	50
9	SHIELD-FLEX® 60–80	60–80	0126*7565*070	0126*7702*070	0126*7703*070	0126*7704*070	0126*7705*070	25
9	SHIELD-FLEX® 70–90	70–90	0126*7565*080	0126*7702*080	0126*7703*080	0126*7704*080	0126*7705*080	25
9	SHIELD-FLEX® 80–100	80–100	0126*7565*090	0126*7702*090	0126*7703*090	0126*7704*090	0126*7705*090	25
9	SHIELD-FLEX® 90–110	90–110	0126*7565*100	0126*7702*100	0126*7703*100	0126*7704*100	0126*7705*100	25
9	SHIELD-FLEX® 100–120	100–120	0126*6565*110	0126*6702*110	0126*6703*110	0126*6704*110	0126*6705*110	25
9	SHIELD-FLEX® 110–130	110–130	0126*6565*120	0126*6702*120	0126*6703*120	0126*6704*120	0126*6705*120	25
9	SHIELD-FLEX® 120–140	120–140	0126*6565*130	0126*6702*130	0126*6703*130	0126*6704*130	0126*6705*130	25
9	SHIELD-FLEX® 130–150	130–150	0126*6565*140	0126*6702*140	0126*6703*140	0126*6704*140	0126*6705*140	25
9	SHIELD-FLEX® 140–160	140–160	0126*6565*150	0126*6702*150	0126*6703*150	0126*6704*150	0126*6705*150	25
12	SHIELD-FLEX® 16–27	16–27	0136*7352*021	0136*7702*021	0136*7703*021	0136*7704*021	0136*7705*021	50
12	SHIELD-FLEX® 20–32	20–32	0136*7352*026	0136*7702*026	0136*7703*026	0136*7704*026	0136*7705*026	50
12	SHIELD-FLEX® 25–40	25–40	0136*7352*032	0136*7702*032	0136*7703*032	0136*7704*032	0136*7705*032	50
12	SHIELD-FLEX® 30–45	30–45	0136*7352*037	0136*7702*037	0136*7703*037	0136*7704*037	0136*7705*037	50
12	SHIELD-FLEX® 35–50	35–50	0136*7352*043	0136*7702*043	0136*7703*043	0136*7704*043	0136*7705*043	50
12	SHIELD-FLEX® 40–60	40–60	0136*7352*050	0136*7702*050	0136*7703*050	0136*7704*050	0136*7705*050	25
12	SHIELD-FLEX® 50–70	50–70	0136*7352*060	0136*7702*060	0136*7703*060	0136*7704*060	0136*7705*060	25
12	SHIELD-FLEX® 60–80	60–80	0136*7352*070	0136*7702*070	0136*7703*070	0136*7704*070	0136*7705*070	25
12	SHIELD-FLEX® 70–90	70–90	0136*7352*080	0136*7702*080	0136*7703*080	0136*7704*080	0136*7705*080	25
12	SHIELD-FLEX® 80–100	80–100	0136*7352*090	0136*7702*090	0136*7703*090	0136*7704*090	0136*7705*090	25
12	SHIELD-FLEX® 90–110	90–110	0136*7352*100	0136*7702*100	0136*7703*100	0136*7704*100	0136*7705*100	25
12	SHIELD-FLEX® 100–120	100–120	0136*6352*110	0136*6702*110	0136*6703*110	0136*6704*110	0136*6705*110	20
12	SHIELD-FLEX® 110–130	110–130	0136*6352*120	0136*6702*120	0136*6703*120	0136*6704*120	0136*6705*120	20
12	SHIELD-FLEX® 120–140	120–140	0136*6352*130	0136*6702*130	0136*6703*130	0136*6704*130	0136*6705*130	20
12	SHIELD-FLEX® 130–150	130–150	0136*6352*140	0136*6702*140	0136*6703*140	0136*6704*140	0136*6705*140	20
12	SHIELD-FLEX® 140–160	140–160	0136*6352*150	0136*6702*150	0136*6703*150	0136*6704*150	0136*6705*150	20

Web: <https://www.dmejde.com>
E-mail: info@dmejde.com

POWERED BY DME&JDE GROUP

DME&JDE GROUP
YOUR CONNECTORS & HOSES OEM SOLUTIONS



CLEAN SEAL CAPSULES (CSC)

Powered by DME&JDE Group



www.dmejde.com

THE SEAL TAKES ONLY TWO SECONDS TO COMPLETE



TWO SECONDS TO COMPLETE

DME&JDE

The Difference With The Traditional Plastic Plug Cover

- 1 Traditional plastic caps are often too loose or too tight. Too loose will cause the plug cover to fall off during transportation, and clean pipelines are polluted; If it is too tight, it will be difficult to pull out the plug cover when disassembling, and even need tools.
- 2 When a tight plug cover is removed, it breaks, and the debris flows into the cleaned pipe, causing secondary pollution.
- 3 DME&JDE thermoplastic plug cover is easily removed without any residue, greatly improving cleanliness and efficiency.

Improved Pipe Cleanliness

The pipe section sealing system uses high-tech thermoplastic technology, which wraps the thermoplastic plug securely around the joint body. The DME&JDE thermoplastic plug cover ensures that your line assembly is 100% sealed, keeping contaminants completely out of the door.

Advantage

Unique "tear strip" design, so that disassembly becomes very fast.

- ▶ Durable and reliable
- ▶ Easy to install and disassemble
- ▶ It won't fall off in transit
- ▶ Elbow straight head can be
- ▶ Just 16 sizes
- ▶ Super clean seal effect
- ▶ Greatly reduce the blocked cover inventory
- ▶ No damage to the sealing ring
- ▶ Disassembled without any residue
- ▶ MAX. 2" connector

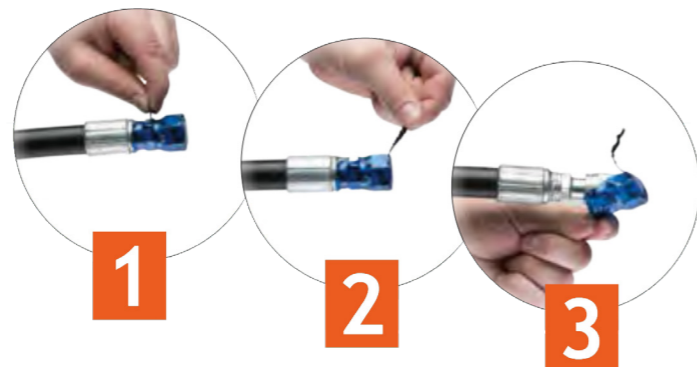

How to Remove the "Thermoplastic Plug Cover" ?

There is a black tear strip on the thermoplastic plugging cover, and a pull will remove the whole thermoplastic plugging cover.

How to Install the "Thermoplastic Plug Cover" ?

Our thermoplastic plug covers only 16 specifications, covering all joint forms within 2 inches, replacing hundreds of specifications of traditional plug covers.

Very convenient to use

1. Choose a thermoplastic plug cover slightly larger than the outer diameter of the joint and set it on the street.
2. Push into the heat gun, and the thermoplastic plug cover begins to shrink.
3. It takes only 2 seconds to remove, and the thermoplastic plug cover wraps and seals the joint perfectly.



Heat Gun



- The temperature of the heat gun is adjustable, ranging from 50 °C to 593°C .
- The heat-resistant material is used to ensure the service life of the heat gun.
- Single-phase 230V AC, rate 1500W, flow 17.6CFM.
- Thermoplastic several hose at the same time.
- The hot air hood generates a 360-degree circulation, which heats the thermoplastic plug uniformly.
- The hot air hood has two interface sizes: 1.5 inches and 2 inches.
- Use No. 304 stainless steel, durable.

Clean Seal Capsules (CSC)

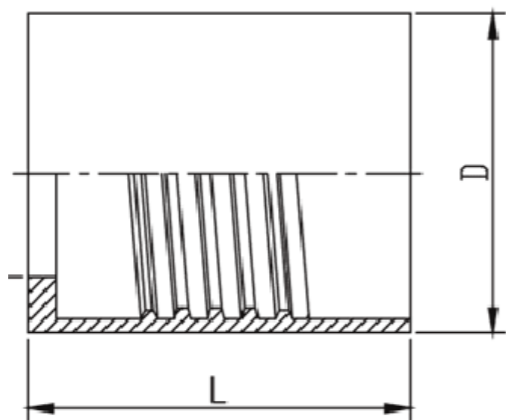

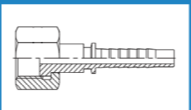
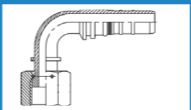
NO.	COAD	Capsules I.D (D)	Capsules Length (L)	Fitting O.D	DME FITTING TYPE		MOQ	FOB PRICE	Remark
		(mm)	(mm)	(mm)			PCS	US\$/PCS	
1	DME&JDE-CscFlex-2023	20	23	12-18		★	60,000	0.069	(If you customize the LOGO, you need to pay an additional 140 US \$/SIZE for the mold)
2	DME&JDE-CscFlex-2030	20	30	12-18	★		60,000	0.069	
3	DME&JDE-CscFlex-2224	22	24	16-21		★	60,000	0.069	
4	DME&JDE-CscFlex-2527	25	27	18-23		★	60,000	0.069	
5	DME&JDE-CscFlex-2540	25	40	18-23	★		60,000	0.069	
6	DME&JDE-CscFlex-2840	28	40	22-26	★		60,000	0.069	
7	DME&JDE-CscFlex-3133	31	33	24-29		★	60,000	0.077	
8	DME&JDE-CscFlex-3140	31	40	24-29	★		60,000	0.077	
9	DME&JDE-CscFlex-3440	34	40	27-32	★		60,000	0.077	
10	DME&JDE-CscFlex-3840	38	40	30-36	★	★	60,000	0.086	
11	DME&JDE-CscFlex-4345	43	45	32-41	★	★	60,000	0.086	
12	DME&JDE-CscFlex-4650	46	50	34-44	★	★	60,000	0.094	
13	DME&JDE-CscFlex-5260	52	60	41-50	★	★	60,000	0.111	
14	DME&JDE-CscFlex-5860	58	60	49-56	★	★	60,000	0.111	
15	DME&JDE-CscFlex-6760	67	60	55-65	★	★	60,000	0.130	
16	DME&JDE-CscFlex-8060	80	60	64-78	★	★	60,000	0.350	

A Hydraulic Hose Assembly



How to order Assembly

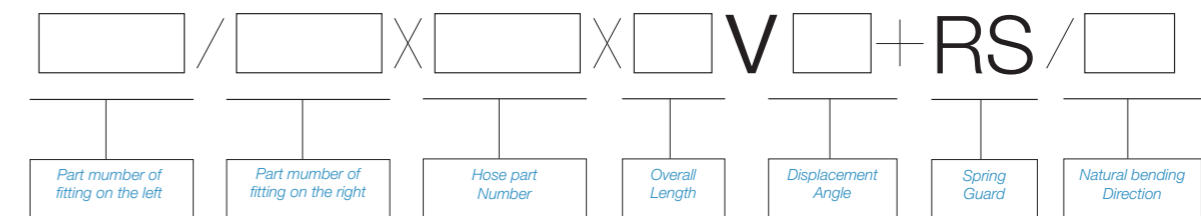
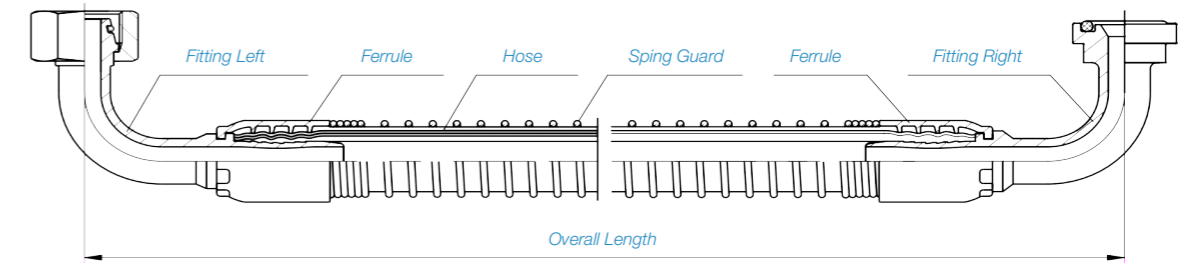

Order example 1: S20491-30-12T/S87391-12-12x 2T12x1200V90+RS/SSX

If there is no assembly angle, natural curvature direction, or spring jacket, these contents can be omitted in the code.

Example 2: When fitting 1 and fitting 2 are the same, only one fitting code is marked.

S20491-30-12Tx 2T12x1200V90



How to measure Assembly

The length of the hose assembly is measured from the end face of the fitting or the center of the bent fitting core as the reference.

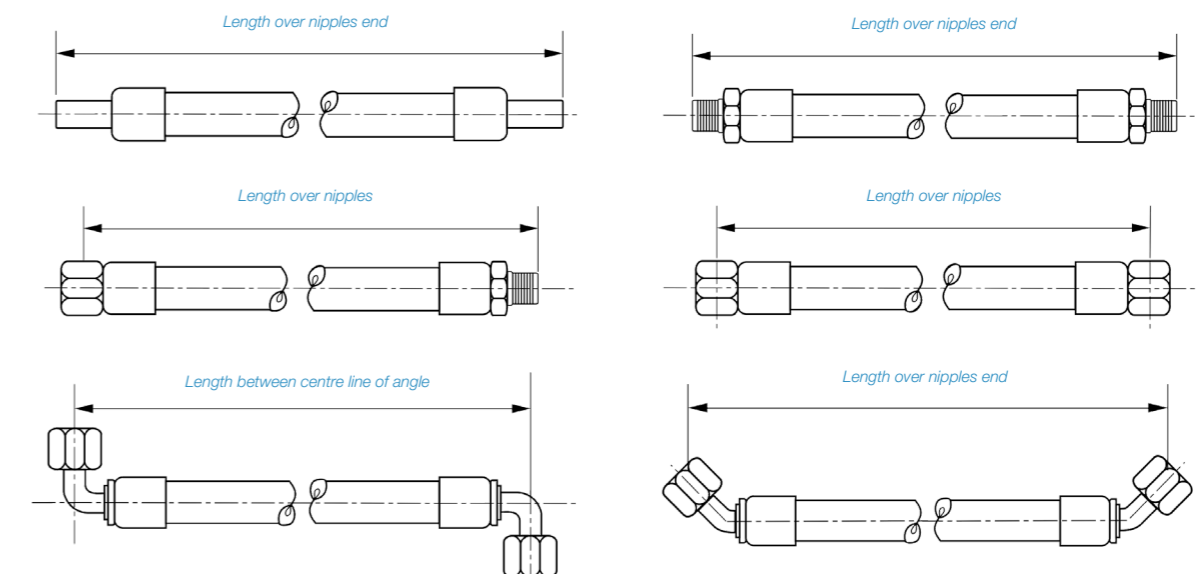



How to measure Displacement Angle

To align the hose assembly in a straight line, one of the fittings is positioned in the vertical direction:

Measure the angle between the other fitting and the vertical fitting in a clockwise direction.

This angle is known as the assembly angle.

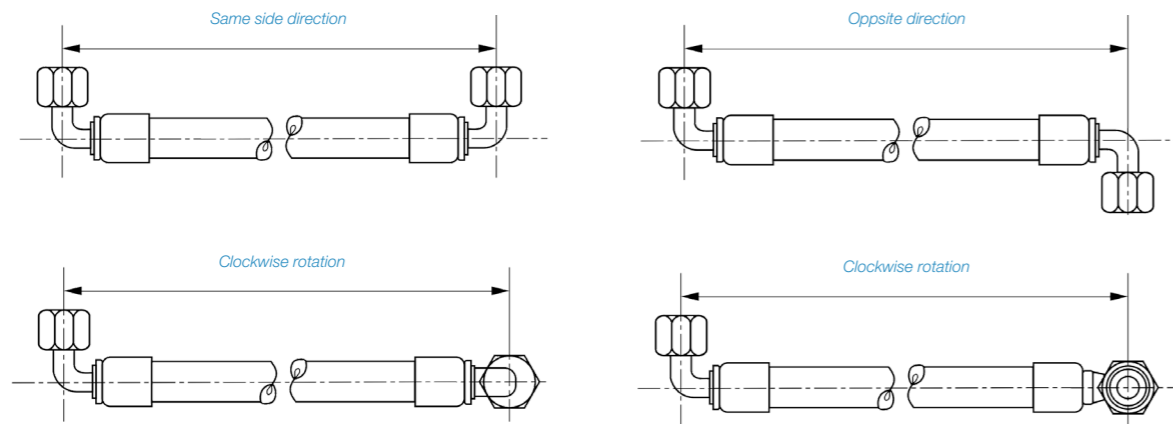

Assembly angle tolerance permit $\pm 3^\circ$

Natural Bending Direction



When both ends of the hose assembly are bent fittings, there is an angular relationship between the two bent fittings during assembly. To measure this, straighten the hose assembly and view it in a straight line. Position bent fitting 1 vertically upwards and measure the angle between bent fitting 2 and the vertically positioned bent fitting 1 in a clockwise direction. This angle is known as the assembly angle of the hose assembly and is represented by α . For example, if the assembly angle α is 225° , it is marked as V225.

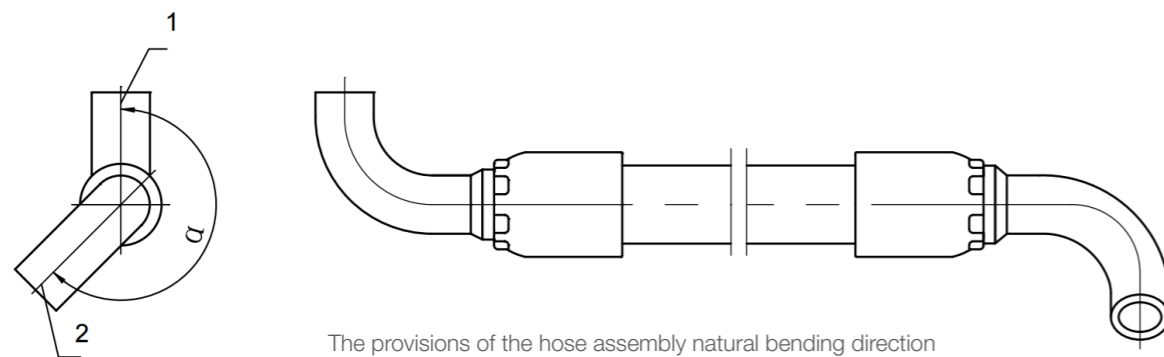

The provisions of the hose assembly natural bending direction

When hoses are stored in coiled bundles, it becomes difficult to straighten them during assembly. When a section of the hose includes a bent fitting, there is a relationship between the bent fitting and the natural curvature of the hose.

Taking the plane in which the hose naturally lies as the horizontal plane.

The bent fitting of the hose assembly can have the following four orientations when connected to another fitting at the other end:

Graphic Description	Explain	Code	Graphic Description	Explain	Code
	Single head with the plane perpendicular and facing outward	DCW		Single head with the plane horizontal and facing upward	DSS
	Single head with the plane perpendicular and facing inward	DCN		Single head with the plane horizontal and facing downward	DSX

The ten possible configurations for bent end fittings in a hose assembly are as follows:

Graphic Description	Explain	Code	Graphic Description	Explain	Code
	Double-ended, horizontally downward	SSX		Dual-headed perpendicular in opposite directions. Fittings 1 inward, fittings 2 outward.	SYC2
	Double-ended, horizontally upward	SSS		Fittings 1 vertically inward, Fittings 2 horizontally upward	YWES
	End fitting 1 downward, and end fitting 2 upward	SSY		Fittings 1 vertically outward, Fittings 2 horizontally upward	YNEX
	Double-ended, parallel in the same plane, outward perpendicular	STC		Fittings 1 vertically inward, Fittings 2 horizontally downward	YWEX
	Dual-headed perpendicular in opposite directions. Fittings 1 outward, fittings 2 inward.	SYC1		Fittings 1 vertically outward, Fittings 2 horizontally downward	SYC2



How to choose with right inside diameter

According to the request of the flow and velocity, we can ascertain the proper inside diameter of hose quickly with the following chart.

Example: How much will the inside diameter be if the flow of the hose is 72L/min pressure line?

Join the point of 72L/min on the flow line and the point of 6.2m/s on the point where this straight line cross the inside diameter line is the cross the inside diameter line is the right inside diameter, here is 15.9mm.

Recommended flow tolerate the hydraulic oil whose maximum.

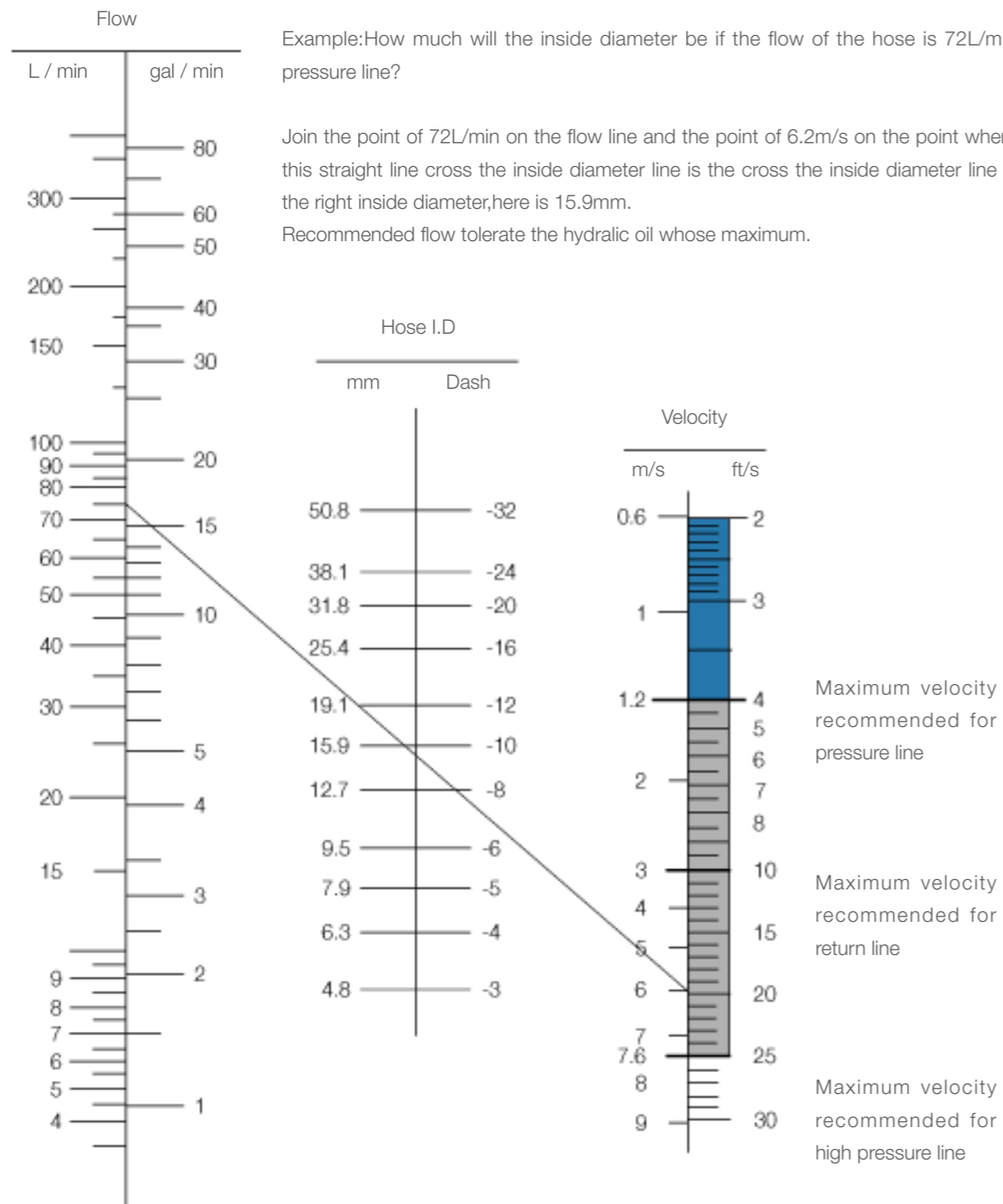

Recommended flow tolerate the hydraulic oil whose maximum



Assembly installation, Technical requirements

Install, the hose in a correct way is very important, it will affect the hoses appearance and cost a lot while it is too long, but if the hose is too short, it cannot flex while being crushed. Both too long and too short can break down the hose. So pay more attention to the following guide before you install the assembly:

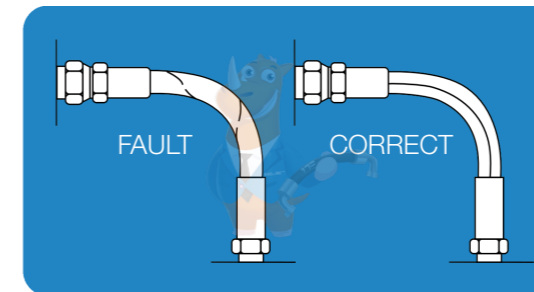

Hose should not be twisted. Hose is weakened when installed in twisted position. Also pressure in twisted hose tends to loosen fitting connections design so that machine motion produces bending rather than twisting.

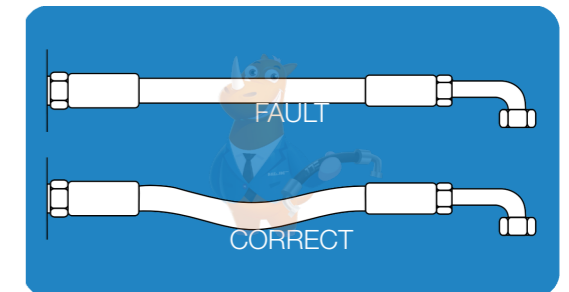

Since hose may change in length from +2% to -4% under the surge of high pressure, provide sufficient slack for expansion and contraction.

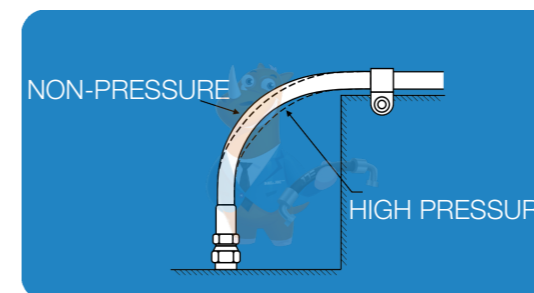

Don't use any clamp at the inflexion so as it can move freely.

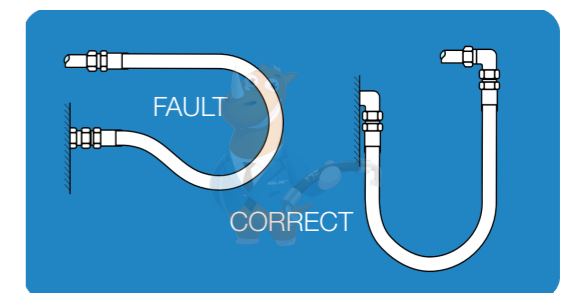

Choose right angle fittings to avoid too small bending radius and excess force.

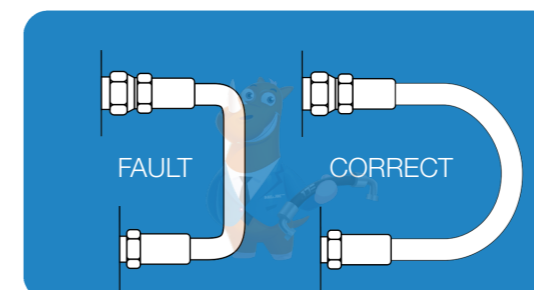

Hose bending radius should be as big as possible when it is in motion.

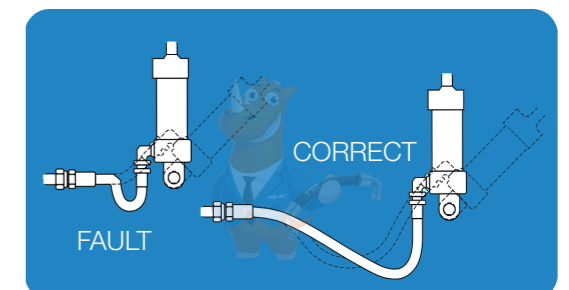

Reduce friction; avoid hose touching the object directly or far away from the object correct assembly installation.



Safety Guide For Hose Assemblies

There are many factors which can affect the usage condition of hose assembly, use the hose assembly and hose fittings in a correct way can ensure its reliability and economical efficiency.

These factors are as follows:

1. Hose Dimension

The selection of hose inside diameter must be correctly made. If the hose inside diameter is too small, it will speed up the medium in the pipe-line, heated the system, lower the efficiency and produce excessive pressure drop which will affect the whole system's capability. If it will fix with hose clamp or cross the steel board, the outside diameter of hose should be pay more attention.

2. Working Pressure

The dynamic working pressure in this catalog refers to the allowable maximum pressure in condition of continuously working. According to the safety modulus of hydraulic hose ruled by international standard, we recommend that the working pressure is one quarter of the minimum blast Pressures.

3. Impact Pressure & Fatigue Life-span

After determining the maximum system pressure for a hydraulic system, hose selection can be made. For the hydraulic system's pressure always be dynamic, there often appears an impact pressure, the maximum impact pressure is much higher than the maximum system pressure. To be luckily, there is an over fallvalve in every hydraulic system, so high impact pressure cannot affect the fatigue life-span seriously. As for hydraulic system whose impact pressure appears very frequently, we advise you choose the special hydraulic hose which is able to endure the high impact Pressure.

4. Temperature Range

User must ensure that the temperature is in an allowable range of hose, if exceeding this range, the life-span of hose will be shorten, and the capacity to endure pressure will get down. If the working condition temperature keep too high or too low in a long time, we advice you use the hose spring guard.

5. Chemical Compatibility

If use special hydraulic medium, user should ensure the material of hose inner side and cover, the hose fittings and O-ring can compatible with the special hydraulic medium.

6. Bending Radius

Pay more attention to its minimum bending radius when install the hose assembly, if the bending radius is smaller than the minimum one, the capacity of enduring pressure will get down and the life-span of hose will be shortened.

7. Friction

We advised you use a spring guard if the hose assembly is always in the condition of touching and making friction with hard object. Any technical question about Stronger Hydraulic hose assembly, welcome to inquire!



Inter miscibility of Hose linina, fittina material, chemical substances

Fluid	E=excellent	C=conditional	U=unsatisfactory	G=good	EPDM	Synthetic Rubber	Teflon	Thermopalstic Elastomer	Steel	Brass	Stainless Steel
					Hose				Metal		
acetaldehyde	E				U			G	G	E	E
acetic acid,glacial	E				U			C	U	U	C
acetic acid,10%	C				U			C	U	U	C
acetone	E				U			G	E	E	E
acetyl acetone	E				U			G	U	C	C
acetyl chloride	U				U			U	C	C	C
acetylene	E				U			G	E	E	E
air wet	E				E			C	U	G	E
aluminum chloride	E				E			E	U	U	U
aluminum fluoride	E				E			E	U	U	U
aluminum nitrate	E				E			E	U	U	C
aluminum sulfate	E				E			G	U	C	E
alums	E				E			E	U	C	E
ammonia,anhydrous	U				U			U	E	U	E
ammonia,aqueous	E				U			U	E	U	E
ammonia,cold	E				U			U	E	U	E
ammonia,hot	E				U			U	E	U	E
ammonia carbonate	E				U			C	C	U	C
ammonia chloride	E				E			C	U	U	C
ammonia hydroxide	E				C			U	G	U	C
ammonia nitrate	E				G			C	G	U	G
ammonia phosphate	E				E			C	U	C	G
ammonia sulfate/sulfide	E				E			C	U	U	G
amyl acetate	E				U			U	E	E	E
amyl alcohol	E				G			E	G	G	E
aniline dyes	E				U			U	U	C	G
aniline,aniline oil	E				U			U	E	U	E
arsenic acid	E				E			G	U	U	G
asphalt	E				C			G	E	G	E
barium chloride	E				E			C	U	G	G
barium hudroxide	E				E			G	G	U	G
barium sulfide	E				E			C	C	U	G
benzene,A97benzol	U				U			C	G	E	E
benzin	U				G			C	E	E	E
benzoic acid	U				U			C	U	G	G
benzyl alcohol	E				U			C	E	G	E
borax	E				G			G	E	E	E
boric acid	E				G			G	U	G	C
brine	E				G			C	U	G	G
bromine	U				U			U	U	C	U
butyl alcohol	E				E			G	G	G	G
butyl stearate	U				U			-	G	G	G
butylene	U				U			-	E	E	E
butyraldehyde	E				U			-	E	E	E
calcium acetate	E				G			C	G	G	G
calcium bisulfate	U				E			G	U	C	C

Fluid	Hose			Metal			
	EPDM	Synthetic Rubber	Teflon	Thermopalstic Elastomer	Steel	Brass	Stainless Steel
calcium chloride	E	E	E	E	G	G	G
calcium hydroxide	E	E	E	C	G	G	G
calcium hypochlorite	E	U	E	C	U	G	C
calcium nitrate	E	E	E	E	G	G	G
cane sugar liquors	E	E	E	E	E	G	E
carbolic acid	E	U	E	U	U	E	E
carbon dioxide	E	G	E	E	E	E	E
carbon disulfide	U	U	E	C	G	G	G
carbon monoxide	E	G	E	E	E	E	E
carbon tetrachloride	U	U	E	U	U	G	G
carbonic acid	E	G	E	C	U	C	E
castor oil	E	E	E	G	E	E	E
cellosolve acetate	E	U	E	U	U	U	E
china wood oil(tung oil)	U	G	E	C	E	G	E
chlorine	U	U	U	U	C	C	C
chloroacetic acid	E	U	E	U	U	U	U
chloroacetone	E	U	E	U	G	G	G
chlorobenzene	U	U	E	U	G	G	G
chloroform	U	U	E	U	G	G	G
chlorsulfonic acid	U	U	E	U	G	U	G
chrome plating solution	E	U	E	-	C	U	U
chromic acid	E	U	E	-	C	U	U
citric acid	E	E	E	C	C	C	C
copper chloride	E	E	E	E	U	U	U
copper cyanide	E	E	E	-	E	U	G
copper sulfate	E	E	E	G	U	C	G
cotton seed oil	U	G	E	E	E	E	E
creosote (coal tar)	U	C	E	U	E	C	E
crude oil	U	G	E	C	G	U	G
cyclohexanone	E	U	E	G	E	E	E
detergent/Water solution	E	E	E	C	G	E	E
dibenzyl ether	E	U	E	-	G	G	G
diesel oil	U	C	E	C	E	E	E
ethyl acetate	E	U	E	C	E	E	E
ethyl alcohol (ethanol)	E	E	E	C	E	E	E
ethyl benzene	E	U	E		E	G	G
ethyl cellulose	E	G	E	C	E	G	G
ethyl chloride	U	U	E	U	E	E	E
ethylene dichloride	E	U	E	U	G	C	G
ethylene glycol	E	E	E	C	E	G	E
ferric chloride	E	G	E	-	U	U	U
ferric nitrate	E	E	E	C	U	U	G
ferric sulfate	E	G	E	C	U	U	E
formaldehyde	E	C	E	C	E	E	E
formic acid	E	C	E	U	U	C	C
fuel oil	U	G	E	E	E	E	E
furfural	E	C	E	-	G	G	G
gasohol	U	U	E	G	E	E	E
gasoline	U	C	E	E	E	E	E
glycerine/glycerol	E	E	E	E	E	G	E



Inter miscibility of Hose linina, fittina material, chemical substances

Fluid	Hose			Metal			
	EPDM	Synthetic Rubber	Teflon	Thermopalstic Elastomer	Steel	Brass	Stainless Steel
helium	E	C	G	C	E	E	E
heptane	U	G	E	E	E	E	E
hexane	U	G	E	E	E	E	E
hydraulic oils	G	G	G	G	G	G	G
polyester/petroleum blend	-	U	E	C	E	E	E
silicone oils	E	E	E	E	E	E	E
straight petroleum base	U	E	E	E	E	E	E
straight phosphate ester	E	U	E	C	E	E	E
water glycol	E	E	E	C	E	E	E
water petroleum emulsion	U	G	E	C	C	E	E
hydrobromic acid	E	U	E	U	E	U	E
hydrochloric acid	C	U	E	U	U	U	U
hydrocyanic acid	E	C	C	-	E	E	G
hydrofluoric acid	C	U	E	U	U	U	U
hydrogen	E	C	C	C	E	E	E
hydrogen peroxide	C	G	E	G	U	U	G
hydrogen sulfide dry	E	U	C	C	E	G	G
isooctane	U	G	E	E	E	E	E
isopropyl alcohol	E	G	E	C	E	E	E
isopropyl ether	U	C	E	-	G	G	G
kerosene	U	C	E	G	E	E	E
lacquer/lacquer solvents	U	U	E	C	U	E	E
linseed oil	U	G	E	G	E	E	E
magnesium chloride	E	E	E	C	E	C	C
magnesium hydroxide	E	G	E	C	E	G	E
magnesium sulfate	E	E	E	C	E	E	E
maleic acid	E	U	E	C	E	G	G
maleic anhydride	U	U	E	C	G	U	F
maleic acid	U	G	E	-	U	-	F
mercuric chloride	E	E	E	E	U	U	U
mercury	E	E	E	E	E	U	E
methanol	E	G	E	C	G	G	E
methyl bromide	U	U	E	U	E	E	G
methyl butyl ketone	E	U	E	C	E	E	E
methyl chloride	U	U	E	U	E	E	E
methyl ethyl ketone	E	U	E	C	G	G	G
methyl isobutyl ketone	G	U	E	U	G	G	G
methyl isopropyl ketone	G	U	E	U	G	G	G
methylene chloride	G	U	E	U	G	G	G
mineral oils	U	E	E	G	E	E	E
naphtha	U	U	E	G	-	-	-
naphthalene	U	U	E	G	E	G	E
natural gas	U	C	U	C	G	G	G
nickel acetate	E	U	E	U	G	C	E
nickel chloride	E	G	E	U	U	U	G
nickel sulfate	U	E	E	U	U	G	G

Fluid	Hose						
	EPDM	Synthetic Rubber	Teflon	Thermopalstic Elastomer	Steel	Brass	Stainless Steel
nitric acid, over 10%	U	U	E	U	U	U	E
nitric acid, to 10%	U	U	E	C	U	U	E
nitrobenzene	E	U	E	U	E	G	E
nitrogen	E	E	E	E	E	E	E
octyl alcohol	E	E	E	E	E	E	E
Oleic acid	U	U	E	G	C	E	G
oleum (fuming sulfuric acid)	U	U	E	U	G	U	G
oxalic acid	E	G	E	C	U	C	C
oxygen	U	U	U	U	G	G	G
palmitic acid	E	G	E	E	G	-	E
para-dichlorobenzene	U	U	E	-	G	G	G
pentane	U	E	E	G	E	E	E
perchloric acid	E	C	E	U	U	U	U
perchloroethylene	U	U	E	U	C	G	G
phenol (carbolic acid)	U	U	E	U	U	E	E
phosphoric acid	E	U	E	U	U	E	E
phosphorous trichloride	E	U	E	U	C	U	C
potassium acetate	E	G	E	-	C	G	C
potassium chloride	E	E	E	E	E	C	E
potassium cyanide	E	E	E	E	C	U	G
potassium dichromate	E	E	E	E	C	C	C
potassium hydroxide (over 10%)	E	C	E	U	G	G	G
potassium hydroxide (to 10%)	E	G	E	C	G	G	G
potassium nitrate	E	E	E	E	G	G	E
potassium sulfate	E	E	E	E	-	-	-
propane	U	C	-	-	E	E	E
propyl acetate	E	U	E	-	E	-	E
propylene	U	U	E	-	E	E	E
refrigerant R-12	U	C	-	G	E	E	E
refrigerant R-13	U	C	-	G	E	E	E
refrigerant R-22	U	U	C	U	E	E	E
sewage	E	E	E	E	G	G	G
soap (water solutions)	E	E	E	C	E	E	E
sodium acetate	E	G	E	-	E	E	G
sodium bicarbonate	E	E	E	E	G	G	E
sodium borate	E	E	E	E	E	E	E
sodium carbonate	E	E	E	E	E	G	G
sodium chloride	E	E	E	E	U	C	C
sodium cyanide	E	E	E	E	E	-	C
sodium hydroxide (over 10%)	E	U	E	C	C	C	C
sodium hydroxide (to 10%)	E	C	E	G	C	G	C
sodium hypochlorite	C	C	E	C	U	U	U
sodium metaphosphate	E	E	E	E	E	G	G
sodium nitrate	E	G	E	E	E	C	E
sodium peroxide	E	G	E	-	C	U	C
sodium perborate	E	G	E	-	U	U	C
sodium phosphates	E	E	E	E	U	E	G
sodium silicate	E	E	E	E	E	E	E
sodium sulfate	E	E	E	E	G	G	G
sodium thiosulfate	E	G	E	E	U	U	C



Inter miscibility of Hose linina, fittina material, chemical substances

Fluid	Hose						
	EPDM	Synthetic Rubber	Teflon	Thermopalstic Elastomer	Steel	Brass	Stainless Steel
soy bean oil	E	C	G	C	E	E	E
stannic chloride	U	G	E	E	E	E	E
steam (up to 388° F)	U	G	E	E	E	E	E
stearic acid	G	G	G	G	G	G	G
styrene	-	U	E	C	E	E	E
shlfur	E	E	E	E	E	E	E
shlfur chloride	U	E	E	E	E	E	E
shlfur dioxide	E	U	E	C	E	E	E
shlfur trioxide	E	E	E	C	E	E	E
shlfuric acid (oven 10%)	U	G	E	C	C	E	E
shlfuric acid (to 10%)	E	U	E	U	E	U	E
shlfurous acid	C	U	E	U	U	U	U
tannic acid	E	C	C	-	E	E	G
tar (bituminous)	C	U	E	U	U	U	U
tartaric acid	E	C	C	C	E	E	E
tertiary butyl alcohol	C	G	E	G	U	U	G
titanium tetrachloride	E	U	C	C	E	G	G
tpluene (toluol)	U	G	E	E	E	E	E
trichlorethylene	E	G	E	C	E	E	E
triclesyl phosphate	U	C	E	-	G	G	G
triethanolamine	U	C	E	G	E	E	E
tung oil	U	U	E	C	U	E	E
turpentine	U	G	E	G	E	E	E
varnish	E	E	E	C	E	C	C
vinyl chloride	E	G	E	C	E	G	E
water (+151° F to +200° F)	E	E	E	C	E	E	E
water (+201° F to +350° F)	E	U	E	C	E	G	G
water (to +150° F)	U	U	E	C	G	U	E
xylene	U	G	E	-	U	-	E
zinc chloride	E	E	E	E	U	U	U
zinc sulfate	E	E	E	E	E	U	E

HOSE PART NO. AND SPECIFICATION

Hose Type	Hose Standard	Hose Number	I.D																
			DASH	5	6	8	10	13	16	19	22	25	32	38	51				
Steel Wire Braid Hose	SAE 100R1AT	1T	Minimum Bend Radius	89	102	114	127	178	203	241	305	419	508	635					
			Work Pressure (Mpa)	20.7	19.0	17.2	15.5	13.8	10.3	8.6	6.9	4.3	3.4	2.6					
	SAE 100R2AT	2T	Minimum Bend Radius	89	102	114	127	178	203	241	305	419	508	635					
			Work Pressure (Mpa)	34.5	34.5	29.3	27.6	24.1	19.0	15.5	13.8	11.2	8.6	7.8					
	DIN 20022 1SN	1SN	Minimum Bend Radius	90	100	115	130	180	200	240	300	420	500	630					
			Work Pressure (Mpa)	25.0	22.5	21.5	18.0	16.0	13.0	10.5	8.8	6.3	5.0	4.0					
	DIN 20022 2SN	2SN	Minimum Bend Radius	90	100	115	130	180	200	240	300	420	500	630					
			Work Pressure (Mpa)	41.5	40.0	35.0	33.0	27.5	25	21.5	16.5	12.5	9.0	8.0					
	GB 3683 1Type	1W	Minimum Bend Radius	90	100	115	130	180	205	240	280	300	420	500	630				
			Work Pressure (Mpa)	21.0	20.0	17.5	16.0	14.0	10.5	9.0	7.0	4.4	3.5	2.6					
GB 3683 2Type	2W	Minimum Bend Radius	90	100	115	130	180	205	240	280	300	420	500	630					
		Work Pressure (Mpa)	35.0	35.0	32.0	28.0	25.0	20.0	16.0	14.0	11.0	9.0	8.0						
Steel Wire Spiral Hose	SAE 100R12	R12	Minimum Bend Radius				127	178	203	241	305	419	508	635					
			Work Pressure (Mpa)				27.6	27.6	27.6	27.6	27.6	20.7	17.2	17.2					
	DIN 20023-4SP	4SP	Minimum Bend Radius		150		180	230	250	300	340	460	560	660					
			Work Pressure (Mpa)		50.0		46.0	42.5	40.0	38.0	32.0	21.0	18.5	17.5					
	DIN 20023-4SH	4SH	Minimum Bend Radius						250	280	340	460	560	700					
			Work Pressure (Mpa)						45.0	42.0	38.5	35.0	30.0	25.0					
	GB 10544 Type-3	4SC	Minimum Bend Radius	100	125	140	150	205	235	280	360	460	560	710					
			Work Pressure (Mpa)	69.0	60.5	56.0	51.5	43.0	38.0	34.5	27.5	20.5	17.0	17.0					
	GB 10544 Type-4	4SE	Minimum Bend Radius					200	280	340	460	560	700						
			Work Pressure (Mpa)					55.0	42.0	38.0	32.5	29.0	25.0						

HOSE AND SUITABLE FITTINGS, FERRULE

Hose Number	I.D	DASH	5	6	8	10	13	16	19	22	25	32	38	51
Fitting						XXXX1-								
Ferrule	S03310-03	S03310-04	S03310-05	S03310-06	S03310-08	S03310-10	S03310-12	S03310-16	S03310-20	S03310-24	S03310-32			
Fitting						XXXX1-								
Ferrule	S00100-03	S00100-04	S00100-05	S00100-06	S00100-08	S00100-10	S00100-12	S00100-14	S00100-16	S00100-20	S00100-24	S00100-32		
Fitting						XXXX1-								
Ferrule	S00200-03	S00200-04	S00200-05	S00200-06	S00200-08	S00200-10	S00200-12	S00200-14	S00200-16	S00200-20	S00200-24	S00200-32		
Fitting						XXXX1-								
Ferrule		S00400-04		S00400-06	S00400-08	S00400-10	S00400-12	S00400-16	S00400-20	S00400-24	S00400-32			
Fitting						XXXX1-								
Ferrule		S00400-04		S00400-06	S00400-08	S00400-10	S00400-12	S00400-16	S00400-20	S00400-24	S00400-32			
Fitting						XXXX2-								
Ferrule						S00400-10	S00400-12	S00400-16	S00400-20	S00400-24	S00400-32			
Fitting						XXXX2-								
Ferrule		S01401-04		S01401-06	S01401-08	S01401-10	S01401-12	S01401-16	S01401-20	S01401-24	S01401-32			
Fitting						XXXX2-								
Ferrule						S01400-08	S01400-12	S01400-16	S01400-20	S01400-24	S01400-32			
Fitting						XXXX2-								



Hose Active Working Pressure-working Life

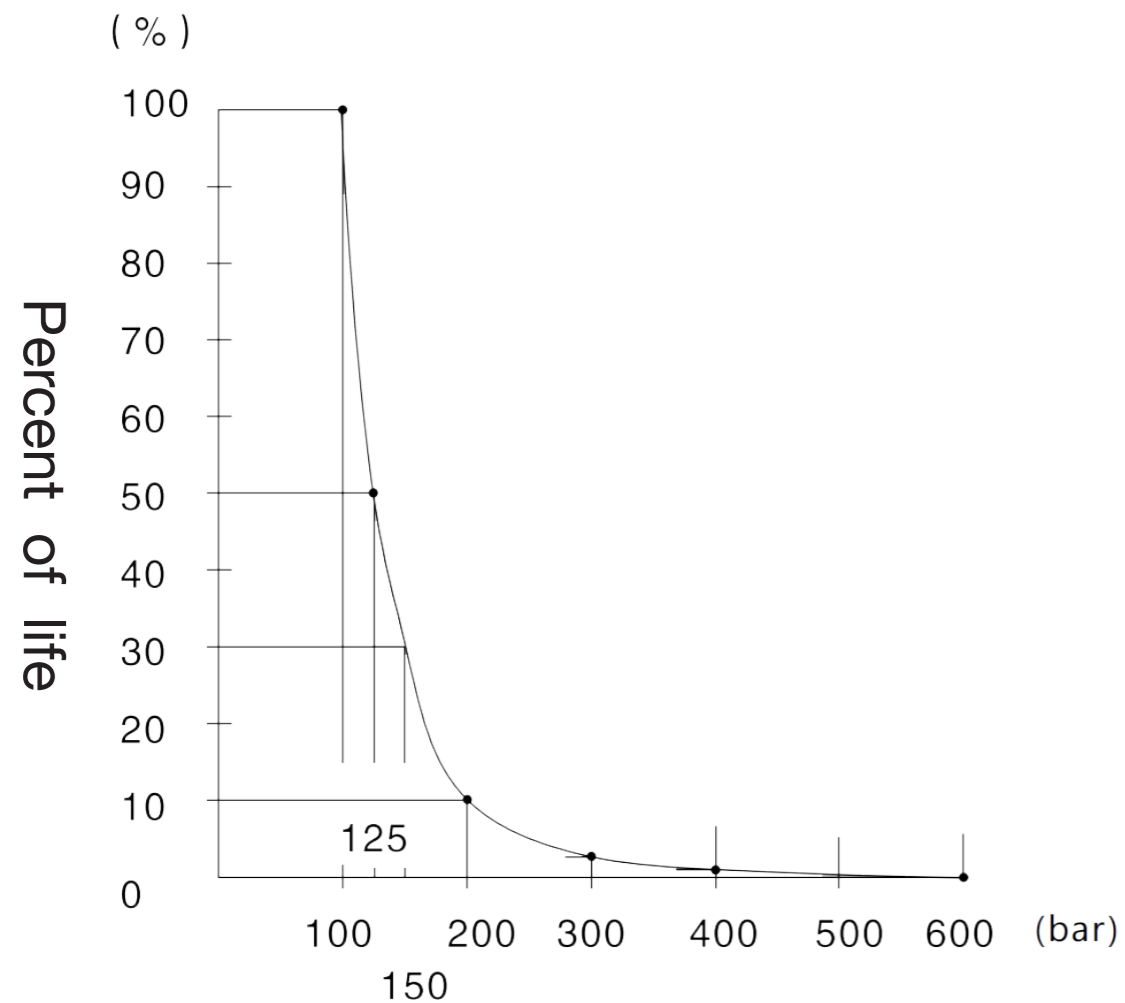

Hose actual working pressure and life

* As shown when active working pressure is 1.25 times recommended working pressure the hose working life is only half of it under working in recommended working pressure.



Storage Requirements

Store conditions of the Assembly:

If possible, the storing temperature range is within 0-35°C , During storing, temperature should not exceed 50°C .

- The storing areas can not place equipments which produce ozone. For example, mercury vapor lamps, high-voltage electrical and other equipments which can produce spark or electricity.
- The storage area should not have devices that generate ozone, such as mercury vapor lamps, high-voltage electrical equipment, electric motors, or other devices that can generate sparks or discharges.
- They should not be stored together with corrosive products or exposed to the vapors emitted by such products.
- They should be kept away from heat sources and equipment that generate electric or magnetic fields.
- Direct exposure to sunlight or intense artificial light sources should be avoided.
- They should not come into contact with sharp objects or the ground.
- They should be stored flat and not stacked too high.
- Measures should be taken to protect them from damage caused by gnawing animals.
- The principle of first in, first out should be followed during storage.



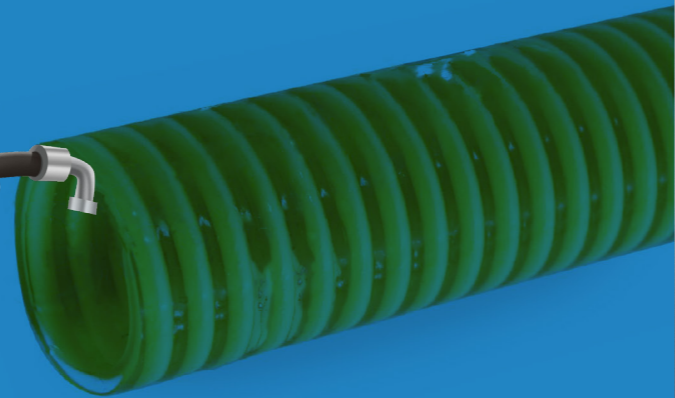
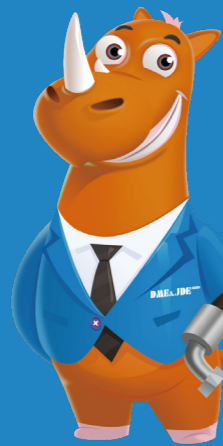

DME & JDE GROUP
 YOUR CONNECTORS & HOSES OEM SOLUTIONS

Web: www.dmejde.com
 E-Mail: info@dmejde.com

Tel: +86-318-2321110
 Mobile: +86-19133858816 [WhatsApp & WeChat]

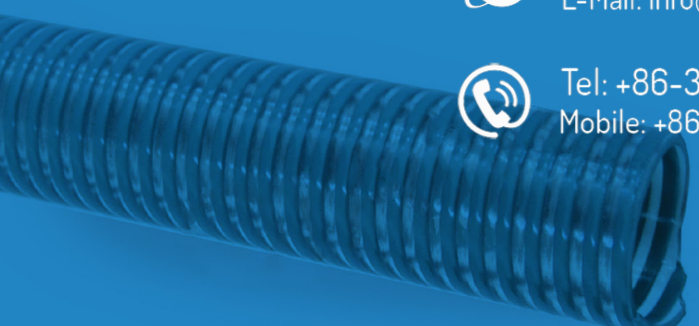

**PVC
 INDUSTRIAL
 HOSE**



DME & JDE GROUP
 YOUR CONNECTORS & HOSES OEM SOLUTIONS





C-Type



F-Type



A-Type



PVC Suction & Fiber Composite Hose

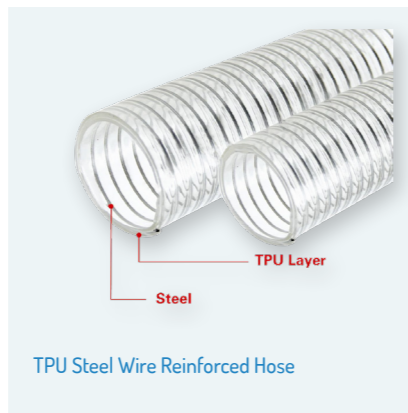

TPU Steel Wire Reinforced Hose



PVC Twin Welding Hose

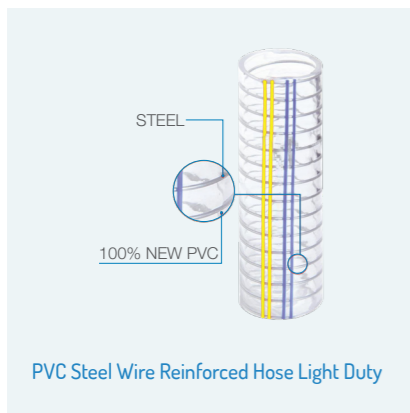

PVC Steel Wire Reinforced Hose Light Duty

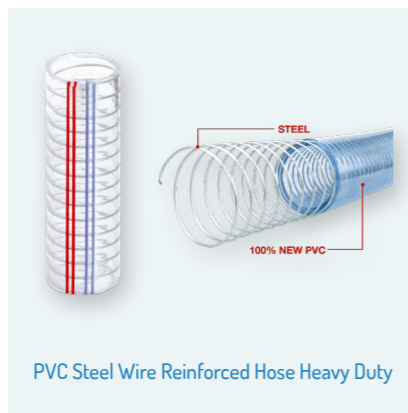

PVC Steel Wire Reinforced Hose Heavy Duty



PVC High Pressure Layflat Hose



QFLEX Layflat Hose

Features

- Made of quality PVC reinforced with an integral helix of rigid PVC.
- Corrugated outer surface provide high flexibility and small bending radius.
- Smooth inner surface are excellent for conveying liquid, air, and powders.
- High abrasion resistant.

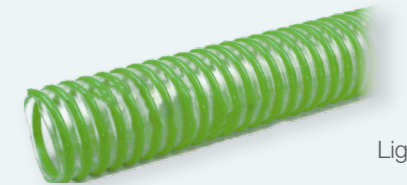

Light Duty



Heavy Duty



PVC Hoses **DME&JDE C-Type**

Specifications

Specification of PVC Suction Hose C-Type (Light Duty)

Inch Size	Metric Size		Length	MAX.W.P		Weight
	I.D. mm	O.D. mm		At 23 °C		
INCH	I.D. mm	O.D. mm	M/ROLL	Bar	Bar	g/m
3/4"	19	23	30	6	18	230
1"	25	29	30	6	18	290
1-1/4"	32	36	30	6	18	350
1-1/4"	32	38	30	6	18	400
1-1/2"	38	44	30	6	18	550
1-1/2"	38	46	30	6	18	650
2"	50	54	30	5	15	550
2"	50	56	30	5	15	700
2-1/2"	63	69	30	4	12	880
2-1/2"	63	71	30	4	12	1170
3"	75	81	30	3	9	1160
3"	75	83	30	3	9	1300
4"	100	108	30	3	9	1950
4"	100	110	30	3	9	2300
5"	125	135	20	3	9	3000
5"	125	137	20	3	9	3300
6"	152	164	10	2	6	4500
6"	152	166	10	2	6	5500
8"	200	214	10	2	6	6300

Specification of PVC Suction Hose C-Type (Heavy Duty)

Inch Size	Metric Size		Length	MAX.W.P		Weight
	I.D. mm	O.D. mm		At 23 °C		
INCH	I.D. mm	O.D. mm	M/ROLL	Bar	Bar	g/m
3/4"	19	25	30	8	24	280
1"	25	31	30	8	24	350
1-1/4"	32	40	30	8	24	500
1-1/2"	38	48	30	8	24	750
2"	50	58	30	7	21	920
2"	50	60	30	7	21	1050
2-1/2"	63	73	30	6	18	1300
3"	75	85	30	5	15	1650
3"	75	87	30	5	15	1900
4"	100	112	30	5	15	2900
4"	100	114	30	5	15	3200
4"	100	116	30	6	18	3700
5"	125	139	20	4	12	3600
5"	125	141	20	4	12	4000
6"	152	170	10	4	12	7200
6"	152	174	10	5	15	8000
8"	200	216	10	3	9	6700

Features

- Smooth inner and outer surface.
- Extensively used in industry and agriculture for pumping and transferring needs.
- Suitable for conveying liquid, powder
- Excellent corrosion-proof protection for cable conduit and piping.
- Excellent flexibility, light weight and small bending radius.

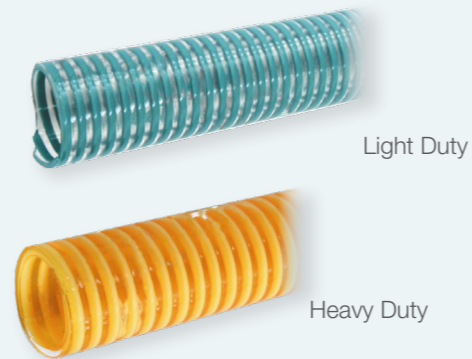

PVC Hoses **DME&JDE F-Type**



Specifications

—Specification of PVC Suction Hose F-Type (Light Duty)—

Inch Size	Metric Size		Length	MAX.W.P		Weight
				At 23 °C		
INCH	I.D. mm	O.D. mm	M/ROLL	Bar	Bar	g/m
3/4"	19	23	30	6	18	230
1"	25	29	30	6	18	290
1-1/4"	32	36	30	6	18	350
1-1/4"	32	38	30	6	18	400
1-1/2"	38	44	30	6	18	550
1-1/2"	38	46	30	6	18	650
2"	50	54	30	5	15	550
2"	50	56	30	5	15	700
2-1/2"	63	69	30	4	12	880
2-1/2"	63	71	30	4	12	1170
3"	75	81	30	3	9	1160
3"	75	83	30	3	9	1300
4"	100	108	30	3	9	1950
4"	100	110	30	3	9	2300
5"	125	135	20	3	9	3000
5"	125	137	20	3	9	3300
6"	152	164	10	2	6	4500
6"	152	166	10	2	6	5500
8"	200	214	10	2	6	6300

—Specification of PVC Suction Hose F-Type (Heavy Duty)—

Inch Size	Metric Size		Length	MAX.W.P		Weight
				At 23 °C		
INCH	I.D. mm	O.D. mm	M/ROLL	Bar	Bar	g/m
3/4"	19	25	30	8	24	280
1"	25	31	30	8	24	350
1-1/4"	32	40	30	8	24	500
1-1/2"	38	48	30	8	24	750
2"	50	58	30	7	21	920
2"	50	60	30	7	21	1050
2-1/2"	63	73	30	6	18	1300
3"	75	85	30	5	15	1650
3"	75	87	30	5	15	1900
4"	100	112	30	5	15	2900
4"	100	114	30	5	15	3200
4"	100	116	30	6	18	3700
5"	125	139	20	4	12	3600
5"	125	141	20	4	12	4000
6"	152	170	10	4	12	7200
6"	152	174	10	5	15	8000
8"	200	216	10	3	9	6700

Features

- Offer with plastic connectors, can be used directly.
- The combining of connectors and hose to prevent leaking.
- Flexible, soft, bend naturally.
- Suitable for drainage water system in agriculture, construction, mining and irrigation purposes.
- Also used for dust collection, vacuum cleaner, swimming pool cleaning.



PVC Hoses **DME&JDE A-Type**



Specifications

—Specification of PVC Suction Hose A-Type—

Inch Size	Metric Size		MAX.W.P		Weight
			At 23 °C		
INCH	I.D. mm	O.D. mm	Bar	Bar	g/m
2"	50.6 ± 1	59 ± 1.5	2.5	9	630
3"	76 ± 1	88 ± 1.5	2	8	1300
4"	102 ± 1.5	117 ± 1.5	1.5	6	2300

Hose length is available in 3 m (10 ft), 4.5 m (15 ft), 6 m (20 ft), 7.5 m (25 ft), and 9 m (30 ft).

Features

- Use high-strength fibers as reinforcement. Combine the features of suction hose & fiber hose.
- Soft and flexible.
- Non-toxic, used for conveying water, oil, powder, and also can be used for conveying wine, juice, etc.
- Crushing abrasion and weather resistance.



DME&JDE PVC Suction & Fiber Composite Hose

Specifications

Specification of PVC Suction & Fiber Composite Hose

Inch Size	Metric Size		Length	MAX.W.P	MAX.B.P	Weight
	I.D. mm	O.D. mm		At 23 °C		
INCH	I.D. mm	O.D. mm	M/ROLL	Bar	Bar	g/m
2"	50	60	30	8	24	1000
2-1/2"	63	74	30	7	21	1400
3"	75	86	30	6	18	1700
4"	102	111	30	6	18	2500
5"	125	143	20	5	15	4400
6"	152	168	10	5	15	5800
8"	200	216	10	4	12	8500

Features

- Used for drawing and conveying water, gas, oil in industry, agriculture, fishing, building and household.
- TPU hose which pass the food grade test can be used for food industry, conveying milk, beer, beverage and so on.
- Best replacement of PVC and rubber hose.
- TPU material reinforced with high-grade steel wire screwing inlaid in the hose.
- Smooth surface, soft, flexible, high corrosion resistance, good resistance to negative pressure ability, high transparency, high abrasion proof, non-toxic, odorless and small bending radius.
- Great low temperature resistance and weather resistance, long life.



DME&JDE TPU Steel Wire Reinforced Hose

Specifications

Specification of TPU Steel Wire Reinforced Hose

Inch Size	Metric Size		Length	MAX.W.P	MAX.B.P	Weight
	I.D. mm	O.D. mm		At 23 °C		
INCH	I.D. mm	O.D. mm	M/ROLL	Bar	Bar	g/m
1/2"	12	18	100	8	24	220
5/8"	15	22	50	6	18	300
3/4"	19	26	50	6	18	360
3/4"	20	26	50	6	18	320
7/8"	22	27	50	6	18	300
1"	25	33	50	5	16	540
1-1/4"	32	40	50	5	16	700
1-1/2"	38	48	50	5	15	1000
1-3/4"	45	56	50	5	15	1300
1-7/8"	48	59	50	5	15	1400
2"	50	62	50	5	15	1600
2-5/16"	58	69	40	4	12	1600
2-1/2"	64	78	30	4	12	2500
3"	76	90	30	4	12	3000

Features

- Being widely used in welding machine, architecture and lacquer factory.
- Used for all kinds of metal-welding and cutting machines to transport oxygen and acetylene.
- Special formula compounding with special PVC resin.
- Good pressure resistance, color resistance, good abrasion resistant and excellent resilience.
- Different color hose for easy using.
- Smooth surface, anti UV, temperature resistance and anti-chemical.



PVC Hoses

DME&JDE PVC Twin Welding Hose



Specifications

Specification of PVC Twin Welding Hose

Inch Size	Metric Size		Length	MAX.W.P	MAX.B.P	Weight
	I.D. mm	O.D. mm		At 23 °C		
INCH	I.D. mm	O.D. mm	M/ROLL	Bar	Bar	g/m
1/4"	6.5	12.5	28	20	60	120
5/16"	8	14	28	20	60	140
3/8"	10	16	28	20	60	165
1/2"	13	20	28	20	60	230

Web: <https://www.dmejde.com>
E-mail: info@dmejde.com

Features

- Used for drawing and conveying water, oil and powder in factory, agriculture.
- Spiral steel wire reinforced incorporated within the wall of flexible PVC tubing.
- Suitable for usual pressure environment.
- High-quality, low price, higher cost performance.
- Anti-UV, smooth surface, temperature resistance, anti-abrasion and anti-chemical.

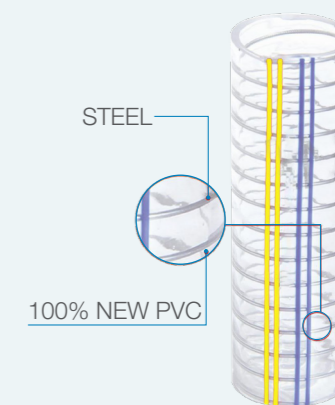

PVC Hoses

DME&JDE PVC Steel Wire Reinforced Hose Light Duty



Specifications

Specification of PVC Steel Wire Reinforced Hose Light Duty

Inch Size	Metric Size		Length	MAX.W.P	MAX.B.P	Weight	Inch Size	Metric Size		Length	MAX.W.P	MAX.B.P	Weight
	I.D. mm	O.D. mm		At 23 °C				I.D. mm	O.D. mm		At 23 °C		
INCH	I.D. mm	O.D. mm	M/ROLL	Bar	Bar	g/m	INCH	I.D. mm	O.D. mm	M/ROLL	Bar	Bar	g/m
3/8"	9	14	100	6	18	150	1-3/4"	45	52	50	3	9	800
3/8"	10	15	100	6	18	160	1-7/8"	48	54	50	3	9	800
1/2"	12	17	100	6	18	170	1-7/8"	48	56	50	3	9	1000
5/8"	15	21	100	6	18	250	2"	50	55.5	50	3	9	800
3/4"	19	24	50	5	15	250	2"	50	57	50	3	9	1000
1"	25	29	50	4	12	220	2"	50	60	50	3	9	1400
1"	25	30	50	4	12	350	2-5/16"	58	65	30	2	6	1200
1-1/4"	32	36	50	3	9	400	2-1/2"	64	72	30	2	6	1500
1-1/4"	32	38	50	3	10	500	2-1/2"	64	75	30	2	6	2000
1-1/4"	32	39	50	3	10	600	3"	76	84	30	2	6	1600
1-1/2"	38	42	50	3	9	500	3"	76	87	30	2	6	2500
1-1/2"	38	44	50	3	9	600	3-1/2"	90	102	20	2	6	3000
1-1/2"	38	45	50	3	9	800	4"	102	112	20	2	6	2800
1-3/4"	45	50	50	3	9	600	4"	102	113	20	2	6	3000

Web: <https://www.dmejde.com>
E-mail: info@dmejde.com

Features

- Used for drawing and conveying water, oil and powder in factory, agriculture.
- Suitable for high strength working environment like suction and discharge for sand.
- Good adaptability to hard weather condition and minus pressure, small bending radius, anti-abrasion.
- Passed the ROHS, PAHS test.
- Anti-UV, smooth surface, temperature resistance, anti-abrasion and anti-chemical.

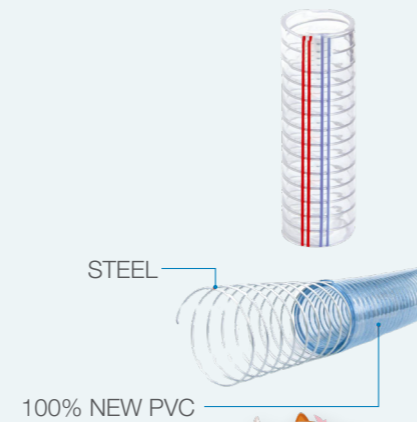

PVC Hoses
DME&JDE PVC Suction & Fiber Composite Hose



Specifications

Specification of PVC Steel Wire Reinforced Hose Heavy Duty

Inch Size	Metric Size		Length	MAX.W.P		Weight	Inch Size	Metric Size		Length	MAX.W.P		Weight
	I.D. mm	O.D. mm		At 23 °C				I.D. mm	O.D. mm		At 23 °C		
INCH	I.D. mm	O.D. mm	M/ROLL	Bar	Bar	g/m	INCH	I.D. mm	O.D. mm	M/ROLL	Bar	Bar	g/m
1/4"	6	11	100	8	24	115	2-5/16"	58	69	40	4	12	1600
5-16"	8	14	100	8	24	150	2-1/2"	64	78	30	4	12	2500
3/8"	9	15	100	8	24	170	3"	76	90	30	4	12	3000
3/8"	10	16	100	8	24	200	3-1/2"	90	108	20	4	12	4500
1/2"	12	18	100	8	24	220	4"	102	116	20	4	12	4300
5/8"	15	22	50	6	18	300	4-3/8"	110	123	20	3	9	4000
3/4"	19	26	50	6	18	360	4-5/8"	117	133	10	3	9	5500
3/4"	20	26	50	6	18	320	5"	127	143	10	3	9	6000
7/8"	22	27	50	6	18	300	5-1/2"	140	156	10	3	9	6500
1"	25	33	50	5	16	540	6"	152	170	10	2	6	8500
1-1/4"	32	40	50	5	16	700	6-5/16"	160	176	10	2	6	8500
1-1/2"	38	48	50	5	15	1000	7"	180	196	10	2	6	8500
1-3/4"	45	56	50	5	15	1300	8"	200	224	10	2	6	12000
1-7/8"	48	59	50	5	15	1400	10"	254	286	10	2	6	20000
2"	50	62	50	5	15	1600							

Super Light Duty (2/3 Bar)

Features

- Used for agriculture.
- Made from high strength polyester and high quality PVC, once-molded by extruder plastic.
- Anti-aging, no smelling, long life.
- Lighter weight, easy to handle and store.
- Anti-UV, temperature resistance, anti-chemical and flexible.



PVC Hoses
DME&JDE PVC High Pressure Layflat Hose Light Duty



Specifications

Specification of PVC High Pressure Layflat Hose (Super Light Duty)

Size		Length	MAX.W.P	MAX.B.P	Weight
Inch Size	Metric Size				
INCH	mm	M/ROLL	At 23 °C		g/m
			Bar	Bar	
2"	51	100	2	8	190
3"	76	100	2	8	280
4"	103	100	2	8	430

Light Duty (4 Bar)

Features

- Irrigation in agriculture and transfer liquid in industry.
- Once-molded by extruder plastic .Small thickness,light weight,high pressure resistance.
- Anti-chemical, anti-aging.
- Environmental grade hose can meet REACH standard.
- Suitable for drip irrigation system.
- Anti-UV, temperature resistance and flexible.

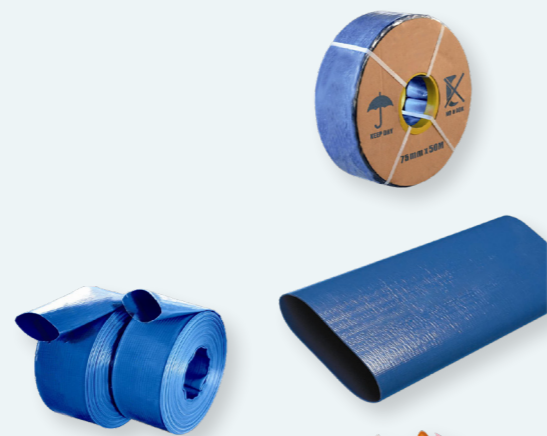

PVC Hoses

DME&JDE PVC Suction & Fiber Composite Hose



Specifications

Specification of PVC High Pressure Layflat Hose (Light Duty)

Inch Size	Metric Size		Length	MAX.W.P At 23 °C	MAX.B.P At 23 °C	Weight
	I.D.	Wall Thickness				
INCH	I.D. mm	mm	M/ROLL	Bar	Bar	g/m
1"	25	1.3	100	4	15	150
1-1/4"	32	1.2	100	4	15	170
1-1/2"	38	1.2	100	4	15	190
2"	51	1	100	4	12	220
2.5"	64	1.1	100	4	12	300
3"	76	1.1	100	4	12	360
4"	103	1.25	100	4	12	550
5"	127	1.35	100	3.5	10	750
6"	153	1.35	100	3	9	900
8"	203	2	100	3	9	1600
10"	255	2.4	100	2.5	7	2600
12"	305	2.35	100	2	6	3000
14"	358	3	50	2	6	5000
16"	408	3	50	2	6	6000

Medium Duty (6 Bar)

Features

- Use for irrigation in agriculture and transfer liquid in industry.
- Higher pressure resistance.
- Good abrasion resistance.
- Environmental grade hose can meet REACH standard.
- Suitable for drip irrigation system.
- Anti-UV, temperature resistance, anti-chemical and flexible.



PVC Hoses

DME&JDE PVC High Pressure Layflat Hose Light Duty



Specifications

Specification of PVC High Pressure Layflat Hose (Medium Duty)

Inch Size	Metric Size		Length	MAX.W.P At 23 °C	MAX.B.P At 23 °C	Weight
	I.D.	Wall Thickness				
INCH	I.D. mm	mm	M/ROLL	Bar	Bar	g/m
3/4"	20	1.35	100	6	21	110
1"	25	1.3	100	6	21	160
1-1/4"	32	1.2	100	6	21	190
1-1/2"	38	1.2	100	6	21	220
1-1/2"	40	1.4	100	6	18	225
2"	51	1.35	100	6	18	300
2.5"	64	1.55	100	6	18	430
3"	76	1.5	100	6	18	500
4"	103	1.9	100	6	18	800
5"	127	2	100	6	18	1080
6"	153	2.4	100	6	18	1600
8"	203	2.6	100	5	15	2200

Heavy Duty (8/10 Bar)

Features

- Discharge sludge in agriculture, construction, industry mining and marine service etc.
- Reinforced with specialized industrial polyester yarn, high pressure resistance.
- Suitable for drip irrigation system.
- Anti-UV, temperature resistance, anti-abrasion, anti-chemical and flexible.



DME&JDE PVC Suction & Fiber Composite Hose

Specifications

Specification of PVC High Pressure Layflat Hose (Heavy Duty)

Inch Size	Metric Size		Length	MAX.W.P	MAX.B.P	Weight
	I.D.	Wall Thickness		At 23 °C		
INCH	I.D. mm	mm	M/ROLL	Bar	Bar	g/m
3/4"	20	1.55	50	10	30	140
1"	25	1.8	50	10	30	200
1-1/4"	32	1.5	50	10	30	210
1-1/2"	38	1.7	50	10	30	290
1-1/2"	40	1.9	50	10	30	300
1-4/3"	45	2	50	10	30	350
2"	51	1.55	50	8	24	350
2"	51	1.8	50	10	30	420
2.5"	64	1.9	50	10	30	700
3"	76	2	50	8	24	660
3"	76	2.55	50	10	30	850
4"	103	2.55	50	8	24	1000
4"	103	2.7	50	10	30	1200
6"	153	3	50	8	24	2000
8"	203	3.2	50	6	18	2800

Features

- Use new material, colorful appearance, high brightness and high tensile strength.
- 30% lighter than PVC in same working pressure, easy to move.
- More environmental than PVC, can be used to convey food.
- Better chemical resistance and aging resistance than PVC.
- Suitable for drip irrigation system.
- Anti-UV, smooth surface, temperature resistance, and anti-abrasion.



DME&JDE PVC High Pressure Layflat Hose Light Duty

Specifications

Specification of QFLEX Layflat Hose

Inch Size	Metric Size		Length	MAX.W.P	MAX.B.P	Weight
	I.D.	Wall Thickness		At 23 °C		
INCH	mm	mm	M/ROLL	Bar	Bar	g/m
1"	25	1.3	100	4	15	110
1-1/4"	32	1.2	100	4	15	130
1-1/2"	38	1.2	100	4	15	150
2"	51	1	100	4	12	180
2.5"	64	1.1	100	4	12	220
3"	76	1.1	100	4	12	270
4"	103	1.25	100	4	12	400
5"	127	1.35	100	3.5	10	550
6"	153	1.35	100	3	9	660
8"	203	2	100	3	9	1150